



FABRICANT
FRANÇAIS
DE MOBILIER
DE BUREAU



Collection 2025/2026

eol-group.net



EOL

Fabricant français de mobilier de bureau

Depuis plus de 35 ans, EOL conçoit et fabrique une offre de mobilier de bureau dédiée à l'aménagement d'espaces de travail favorisant le bien-être des collaborateurs.

Inspirée par l'esthétique du design français, notre offre de mobilier est fonctionnelle, créative et durable.



NOUS FONDONS NOTRE SAVOIR-FAIRE SUR UNE TRIPLE COMPÉTENCE

Création et fabrication française

Du design à la conception, nous maîtrisons le travail du bois, du métal et de la tapisserie

Conseil en aménagement

Nous vous accompagnons dans vos projets d'aménagement de A à Z

Une organisation logistique structurée et globale

Nous stockons, livrons et installons votre mobilier



+ 250
collaborateurs



2 sites
de production
en France



7 pays livrables
rapidement sur stock
(FR, BENELUX, UK, IRL et CH)



20 000 m²
d'espace
de stockage

La qualité et le design Made In France

Nos gammes de mobilier de bureau sont issues de notre savoir-faire de producteur français. Elles sont imaginées par notre studio design, développées par notre bureau d'étude et produites dans nos deux usines françaises, en Normandie et en Bourgogne.

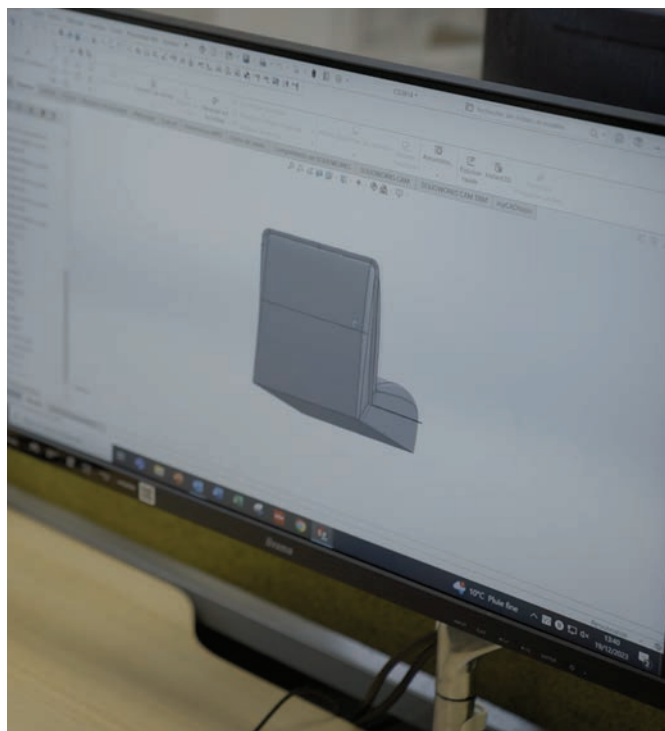
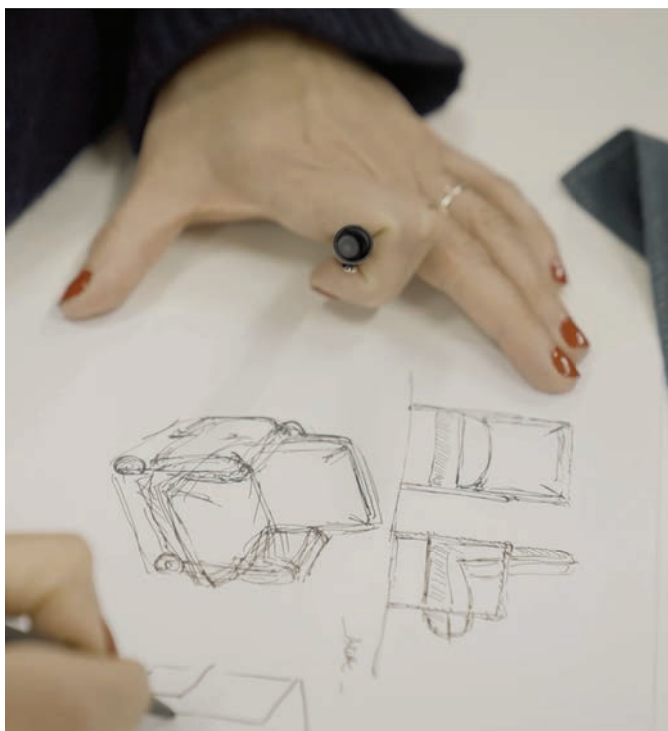

**INSPIRÉS PAR
L'ESTHÉTIQUE
DU DESIGN FRANÇAIS,
NOUS DESSINONS,
CONCEVONS ET FABRIQUONS
UNE OFFRE DE MOBILIER
FONCTIONNELLE, CRÉATIVE
ET DURABLE.**



Livraison, montage et installation de mobilier de bureau

Grâce à une logistique de pointe, à partir d'un dépôt central relayé par 12 plateformes régionales en Europe, EOL offre des délais rapides de livraison et d'installation.



2 usines (Normandie & Bourgogne)

1 siège social (Saint-Denis)

3 showrooms (Paris, Bruxelles et Nieuwegein)

12 plateformes logistiques (France & Europe)

Nos certifications, labels et normes

Afin de garantir la qualité et la durabilité de nos produits, nos principales gammes sont certifiées NF Environnement, Office Excellence et sont conformes aux normes en vigueur telles que la norme EN1335 ou EN 527.

Notre usine de Normandie est certifiée ISO14001.

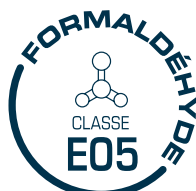

Notre engagement environnemental

Conscient de l'impact de ses activités sur l'environnement, EOL a, depuis plusieurs années, engagé sa transition vers le développement durable. EOL a adopté la technique de l'analyse de cycle de vie des produits qui permet d'évaluer les impacts environnementaux d'un produit au fil de son existence, de sa conception à sa gestion en fin de vie.

Les quatre axes structurants de notre engagement :

- Une production en France et des achats de proximité
- L'utilisation de matériaux et produits à fort taux de recyclage
- La rationalisation de notre production et l'optimisation des flux de transport
- Des produits éco responsables et éco conçus



Pourcentage moyen de matières recyclées des produits référencés de l'offre EOL



RÉEMPLOYER, RECYCLER, UPCYCLER

Dans le cadre de notre projet RE-SOURCE, nous imaginons des solutions pour intégrer dans nos gammes des matériaux issus du ré-emploi, du recyclage, de l'upcycling.

Des panneaux de bois issus de chutes servant de structure à nos canapés, de la mousse de matelas recyclée dans nos cloisons, ou des plateaux produits à partir de plastique recyclé en sont des exemples.

Nous proposons également à nos clients de reconfigurer, réindustrialiser leurs anciens bureaux, et nous récupérons des produits d'occasion afin de leur offrir une deuxième vie.

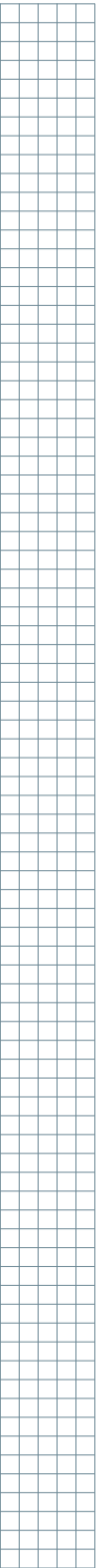

Nos engagements

Notre stratégie, nos actions quotidiennes, nos comportements, nos produits et services sont guidés par des valeurs fortes qui soutiennent les finalités suivantes :

Favoriser le bien-être
des utilisateurs

Garantir la qualité
et la sécurité de nos produits

Placer l'innovation
au cœur de nos préoccupations

Avoir un impact positif
sur la société

Notre approche



UNE OFFRE POUR CHAQUE USAGE

Nous plaçons l'utilisateur au coeur de notre démarche de développement produit et d'aménagement

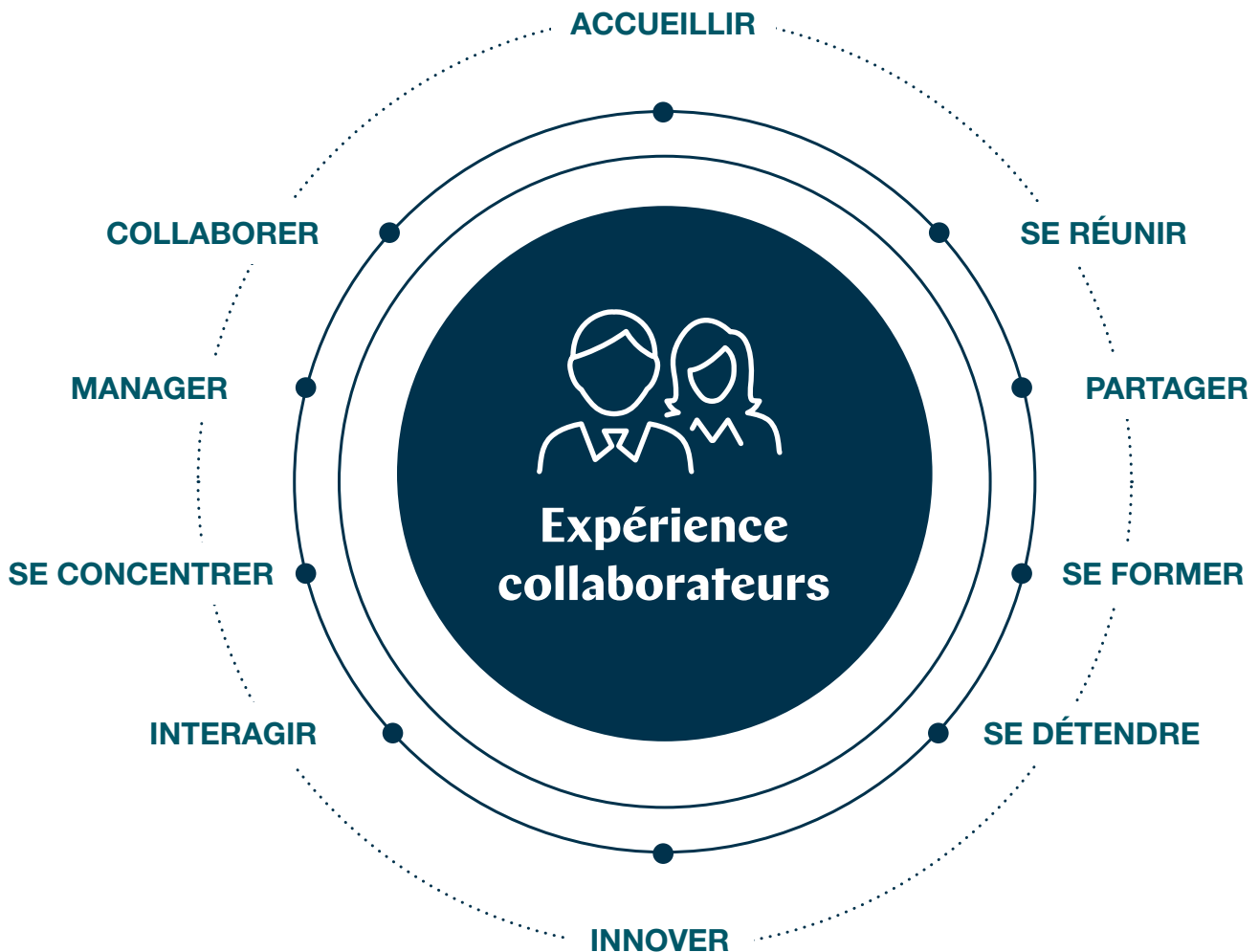

Nos services :

Des solutions globales pour des projets uniques.

Plus que jamais, l'aménagement des espaces tertiaires est un outil de management et de performance des organisations. Au cœur des problématiques d'aménagement depuis plus de 35 ans, nous vous accompagnons dans la réalisation de vos projets.



ÉCOUTER

COMPRÉHENSION DES BESOINS

Définir le périmètre
de votre projet

Restituer vos enjeux
et contraintes



ANALYSER

MATÉRIALISATION DU PROJET

Imaginer les solutions
qui correspondent à vos besoins
et à votre budget



FABRIQUER

PRODUCTION FRANÇAISE

Maitrise du travail du bois, du métal
et de la tapisserie (2 usines en Bourgogne
et Normandie)

Fabrication de mobilier standard
ou sur mesure



STOCKER

LIVRAISON RAPIDE

Une majorité de produits disponibles
sur stock dans les finitions les plus
demandées

Suivi en temps réel de la disponibilité
des produits (EOL.net)



INSPIRER

TENDANCES ET PROSPECTIVE

Écoute et analyse des tendances sociétales, des usages et des nouvelles technologies

Identité d'entreprise, univers de styles et ambiance de travail



AMÉNAGER

IMMERSION ET ACCOMPAGNEMENT

Zoning, respect des flux et modes de travail

Visualisation et projection d'espaces en 2D et 3D pour décider et communiquer



LIVRER ET INSTALLER

SERVICE LOGISTIQUE À LA CARTE

Livraison, dépose, et/ou montage du mobilier

12 plateformes de dégroupage, des équipes d'installateurs professionnels



SUIVI ET QUALITÉ

ASSISTANCE ET SAV

Des produits certifiés & garantis

Suivi des installations et du parc mobilier une fois équipé

Inspirations 2025-2026

Au plus près des tendances

Pour vous guider dans la création d'espaces de travail uniques, découvrez 7 styles décoratifs imaginés par notre studio design. Ils mettent à l'honneur les matières et couleurs de notre nuancier général apportant à vos aménagements différents caractères.



Minimaliste

Simple
Essentiel
Serein

N8

DF

Z8



Green working

Naturel
Engagé
Vivant

MG

RI

B2



Nouveau classique

Tradition
Statutaire
Sobriété

BN

N5

N6



Ocr'attitude

Terrestre
Nature
Chaleur

R8

DJ

DZ

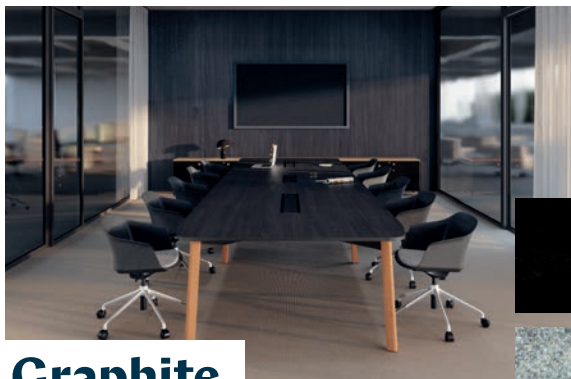

Graphite

Élégant
Noir & bois
Caractère

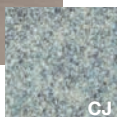
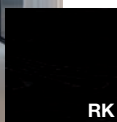

Cocoon

Épuré
Apaisant
Organique

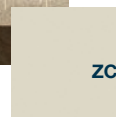

Jaune pep's & bleu ombré

Vibrant
Contrasté
Engageant

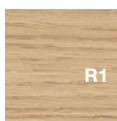
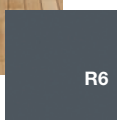
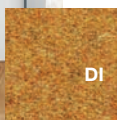

**DÉCLINÉS SUR TOUTES NOS
GAMMES DE PRODUITS,
NOS STYLES DÉCORATIFS
PERMETTENT D'APPORTER
DE L'UNITÉ
À VOTRE AMÉNAGEMENT.**

Une offre de produits disponible en stock ou sur demande

Pour répondre à la diversité des projets d'aménagement, notre offre a été construite pour s'adapter à vos contraintes de style et de temps.

Nous vous offrons différentes possibilités de délais de livraison en fonction des articles et des nuances sélectionnés.

PRODUITS EN STOCK

Une vaste sélection d'articles et de nuances sur stock

LIVRABLE À PARTIR DE **10 JOURS**

PRODUITS SUR DEMANDE

Une sélection d'articles et de nuances sur demande

LIVRABLE EN **4 à 6 SEMAINES**

PRODUITS SUR MESURE

Nous personnalisons notre mobilier en fonction de vos projets (nuances, dimensions...)

LIVRABLE EN **6 à 8 SEMAINES**

COMPRENDRE NOS PICTOGRAMMES

Fabriqué en France



Fabriqué en France



Fabriqué en Europe



Siège à monter soi-même



Siège pré-monté (assise et dossier montés, lift, piétement et roulettes à monter) - Hors accoudoirs



Possibilité d'empiler des chaises



Possibilité d'empiler des chaises sur chariot

Un catalogue papier et des supports digitaux pour vous faciliter la vie

Suivez le fil de vos inspirations à travers le catalogue.
Lorsque vous souhaitez en savoir plus, scannez le QR code à disposition dans les pages produit.

Il vous donne accès à des informations détaillées :
banque d'images, fiches techniques, finitions...

- 1 -

Choisissez

les produits qui vous
intéressent dans le
catalogue



- 2 -

Scannez le QR Code

TOUTES LES
RESSOURCES
ON LINE



- 3 -

Consultez

les fiches techniques
et accédez à
des informations
complémentaires
sur le site

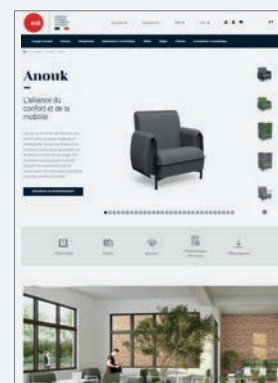

Nuancier tissus

Cat. A, B, C, D disponibles sur délai.

L'ensemble des coloris est présenté en page 290



Renvoi vers les pages « connective »



Surface anti-bactérienne garantie pour tous les plateaux
en mélamine



Pourcentage issu de matières recyclées



Mobilier conforme

aux personnes à mobilité réduite (PMR)

Sommaire

Espaces lounge & accueil

18

Assises modulaires	22
Chauffeuses et canapés	28
Tables basses	46
Banques d'accueil	50
Poutres	62

Espaces de travail

64

Bureaux direction	66
--------------------------	----

Bureaux collaborateurs & Séparations	84
---	----

Bureaux	86
Bureaux assis-debout	110
Séparations	120

Rangements	128
-------------------	-----

Tower & caissons	130
Rangements de proximité	140
Armoires	142
Meubles casiers	146
Classeurs	155
Rayonnages	156
Vestiaires	158

Espaces réunion & collectivités

160

Tables de réunion	164
Tableau mobile	192
Cabines acoustiques	198
Tables multiusage	202
Tables de restauration	216

Assises 222

Sièges de travail 224

Sièges opératifs 226

Sièges ergonomiques 228

Sièges direction 236

Sièges spécifiques 239

Chaises 240

Chaises visiteurs 242

Chaises multiusage 248

Chaises restauration 258

Accessoires & électrification 268

Luminaires 272

Végétaux décoratifs 274

Corbeilles de tri sélectif 278

Porte-manteaux 280

Vestiaire mobile 281

Tableaux 281

Accessoires de bureau 282

Supports multimedia 283

Bras supports écrans 284

Connectique 286

Nuancier 290



Espaces Lounge & Accueil



Lounge & accueil



Zélie

Page 22 ›

.....



Anouk NOUVEAU

Page 28 ›

.....



Margot

Page 34 ›

.....



Côme NOUVEAU

Page 40 ›

.....



Galway

Page 41 ›

.....



Bip

Page 42 ›

.....



Tables basses

Page 46 ›

.....



Suzy NOUVEAU

Page 48 ›

.....



Greta

Page 50 ›

.....



Guest

Page 56 ›

.....



Évasion

Page 62 ›

.....



Rosalie

Page 63 ›

.....



Sosi

Page 63 ›

.....





Zélie

JOUER AVEC LES FORMES ET LES COULEURS

Avec ses formes géométriques, ZÉLIE signe d'un trait contemporain les espaces de travail.

Fabriqué
en France





Bureaux CONECT, p. 90 - Sièges ELIOTT, p. 234 - Casiers CAMILLE p. 146

Modules d'angle, carrés ou rectangulaires, mobiles ou fixes, les multiples possibilités de ZÉLIE rendent l'espace aussi unique que confortable.



Points forts



Reconfigurable

Assise 1, 2 ou 3 places,
avec ou sans dossier



Tablette écrivain

Elle se déplace facilement
selon les besoins



Connectée

Prises directement accessibles
via les modules de liaison



Zooms



Modules de liaison



Connectique intégrée

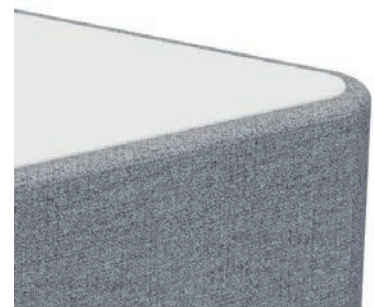

Plateau métal



Zooms



Assise mobile
2 roues arrière



Système de liaison
Rétractable



⌘
↗
**Exemples
de configurations**



^
Se réunir

Avec une tablette écri-
toire, elle ajoute une surface de travail
et se déplace à volonté



^
Brainstormer

En version mobile, ZÉLIE apporte de l'agilité aux espaces
de brainstorming

Synoptique

Assises sans dossier | Modules de liaison

Avec ou sans connectique

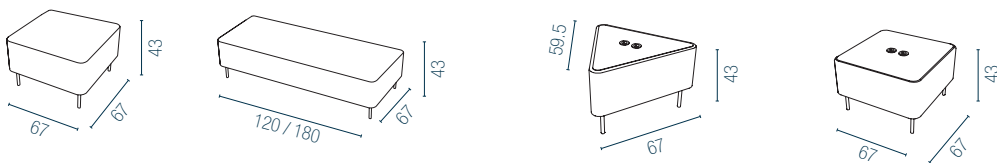

Assises avec dossier

Fixe

Mobile

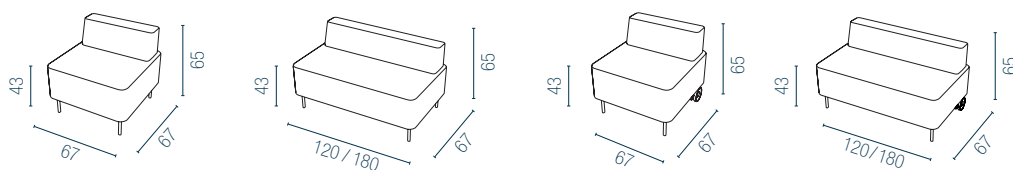

Poufs | Tables basses | Tablettes écrivains

Fixe ou mobile

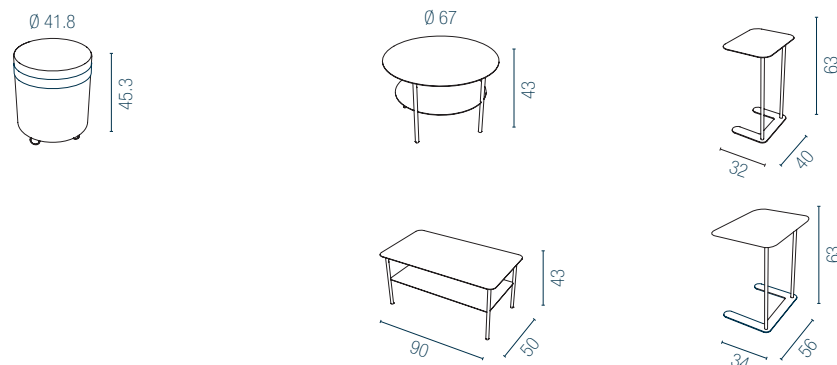

Nuancier

Tissu
Assise et dossier

-  **Cat. A**
Bondai
-  **Cat. B**
Step
Step mélange
Chili
-  **Cat. C**
Secret
-  **Cat. D**
Fenice
Cyber

Métal
Piétements, tables

-  **SO**
-  **SG**
-  **ZO**
Structuré
-  **SC**

TARIF P. 06
↓
Détails et disponibilités

**TOUTES LES RESSOURCES
EN LIGNE**
↓



Accueillir

Jouer avec le module d'angle !



Patienter

Le module d'angle permet de rester connecté pendant l'attente



Anouk

L'ALLIANCE DU CONFORT ET DE LA MOBILITE

Inspirée par le confort des fauteuils club, ANOUK offre une assise moelleuse et enveloppante. Conçue sur la base d'une structure en acier, l'ajout d'accoudoirs ou de cloisons transforme son usage. Une conception astucieuse qui lui permet d'équiper les espaces d'accueil, de concentration, de restauration ainsi que les zones de réunions informelles.

Fabriqué
en France



PEFC
PEFC/07-32-197
Hors cloisons





Banque d'accueil GUEST, p. 56 - Lampadaires CL05, p. 273 - Tables basses MARGOT, p. 46 - Rangements GRETA, p. 50

Afin d'apporter de la modularité aux espaces de travail, ANOUK est également disponible en version mobile. Plus qu'une simple assise, ANOUK structure et reconfigure les espaces avec confort, agilité et élégance.



Points forts



Confortable

Une assise généreuse au confort souple et des accoudoirs épais et moelleux qui renforcent le sentiment de confort

Une hauteur d'assise légèrement réhaussée pour les espaces de restauration



Espace reconfigurable

La version mobile avec roulettes, permet de déplacer facilement les assises



Durable

Âme des accoudoirs constituée en coton recyclé et issue d'une filière française et écoresponsable

Bois PEFC issus de forêts gérées durablement (dessous des assises)



Zooms



Passe-poil



Formes arrondies



Accoudoirs tapissés (option)



^
Pieds fixes



^
Roulettes à l'avant



^
Cloison avec tête



Tables ELOISE p. 210

Exemples de configurations



Se détendre

Une assise moelleuse et enveloppante pour équiper les zones d'attente, de détente ou de réunions informelles



Se restaurer

En version canapé ou box isolé, ANOUK crée des espaces de restauration à la fois intimes et conviviaux

Synoptique

Assises lounge - Hauteur d'assise 45.3 cm

Fauteuil 1 place

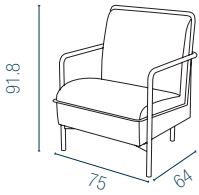

4 pieds

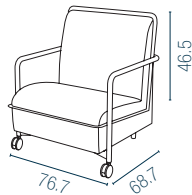

2 pieds fixes/2 roulettes

Canapé 2 places

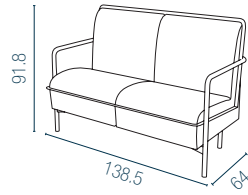

4 pieds

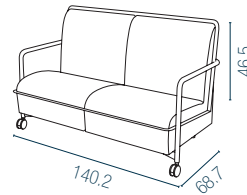

2 pieds fixes/2 roulettes

Assises restauration - Hauteur d'assise 51.7 cm

Fauteuil 1 place

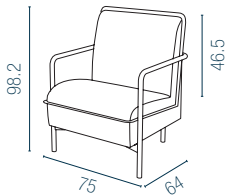

4 pieds

Canapé 2 places

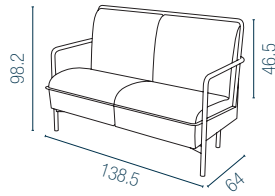

4 pieds

Options

Cloisons

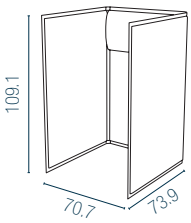

1 place

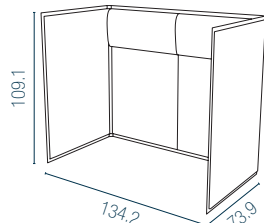

2 places

Accoudoirs tapissés

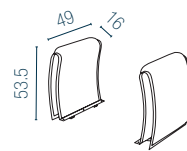

Lot de 2



Les cloisons et les accoudoirs ne peuvent pas être installés ensemble



Se concentrer

Une fois cloisonnée, ANOUK permet de s'isoler pour mieux se concentrer



Échanger

En version mobile, ANOUK apporte de l'agilité aux espaces de créativité

Nuancier

Tissu

Assise et dossier



Cat. B
Step
Step mélange
Chili



Cat. C
Secret



Cat. D
Fenice
Cyber

Métal

Piètements



Z3



Z0



SC



SU



ZP

TARIF P. 07

Détails et disponibilités

TOUTES LES RESSOURCES
EN LIGNE





Margot

L'ART DE VIVRE À LA FRANÇAISE

MARGOT habille avec raffinement les espaces. Son élégance tient à l'équilibre audacieux de ses formes, au contraste créé par l'association d'une assise moelleuse avec un piètement aux lignes épurées.

Fabriqué
en France



PEFC
PEFC/07-32-197





Tables basses MARGOT p. 46 - Rangements GRETA, p. 50

Un style distinctif qui n'oublie pas d'être fonctionnel. Les assises disposent d'un accès direct à la connectique. Multiusage, elles s'adaptent autant aux espaces d'accueil qu'aux zones informelles des espaces de travail.



Points forts



Détail des finitions

Un passepoil souligne les courbes de l'assise



Connectée

Assises et plateaux équipés de prises avec connexion directe (PC + USB-A)



Multiusage

Haut ou bas dossier, avec ou sans cloison, les assises permettent de varier les usages : fauteuil isolé, zone d'attente, de détente ou de réunion informelle



Zooms



Passe-poil



Piètement

Métal



Piètement

Bois



^
**Lignes arrondies
et enveloppantes**



^
Électrification des 2 côtés
de l'assise à droite et à gauche



^
Tablette pivotante
Plateau en mélamine



Armoires ARMAND p. 142 - Lampes CHAMPI, p. 272

Exemples de configurations



Se détendre

En version bas dossier, idéale pour les coins cosy dans un bureau de direction, un espace détente ou d'accueil



Accueillir

Jouer avec les hauteurs pour délimiter les espaces ouverts ou les zones de circulation

Fauteuils et Canapés

Bas dossier

Avec ou sans connectique

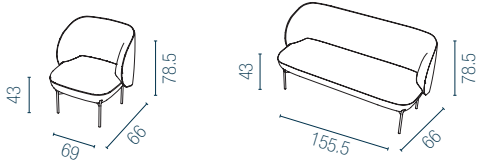

Haut dossier

Avec ou sans connectique

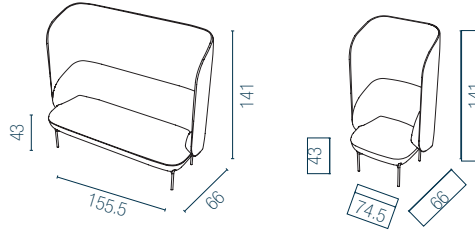

Cloisons avec table | Méridienne | Tables basses

Avec connectique

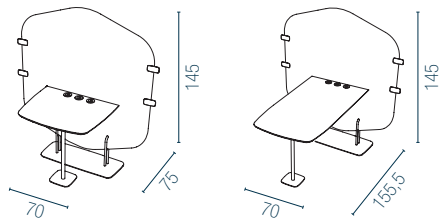

Avec ou sans connectique

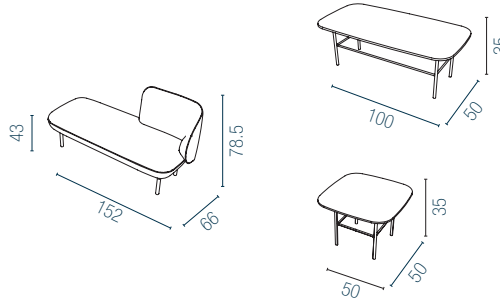

Pouf | Accessoires

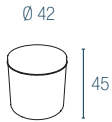

Fixe (sur vérins)

Tableau écriture

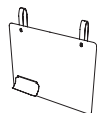

Tête à tissu ou coussin



Tablette pivotante



Kit d'électrification



Se concentrer

Un fauteuil 1 place en version haut dossier pour s'isoler ou travailler



Se réunir

À 2 ou 4 personnes, au sein d'un espace ouvert

Nuancier

Tissu

Assise et dossier



Métal

Piètements, tables

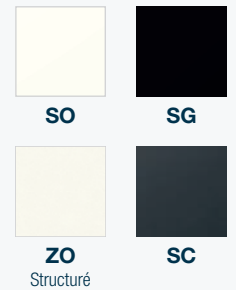

Métal / Bois

Piètement des assises

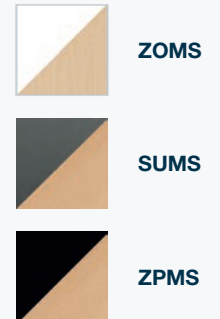

TARIF P. 09

Détails et disponibilités

TOUTES LES RESSOURCES EN LIGNE



Côme

NOUVEAU



Tables basses SUZY, p. 48



Des lignes douces et arrondies

pour un confort enveloppant



Une conception alliant robustesse et confort

Structure solide en bois et mousse injectée densité 40 kg/m³



Modulez vos espaces

CÔME existe en version fauteuil 1 place ou canapé 2 places

Nuancier spécifique

Tissu Bondai Cat. A



KZ
Rouge



KE
Noir



K2
Bleu marine



KD
Gris nuage



KA
Gris orange

Simili cuir Cat. B



BU
Noir



BV
Gris

TARIF P. 12

Détails et disponibilités

TOUTES LES RESSOURCES
EN LIGNE



Galway



Un classique intemporel
aux lignes épurées



Confort ferme



Version Non Feu
(mousse interne avec tissu Mirage)

Nuancier spécifique

Similicuir INCA Cat. A



EG
Noir



EH
Gris clair



EI
Sable



EJ
Beige



EK
Vert foncé



EL
Bleu marine



EM
Rouge
Bordeaux

Tissu non feu MIRAGE Cat. B



WA
Noir



WB
Gris foncé



WG
Bleu navy



WI
Orange



YB
Noir

Cuir Cat. E

TARIF P. 12
Détails et disponibilités
TOUTES LES RESSOURCES
EN LIGNE





Bip

Tables conférence MODULO p. 178

GÉNÉROSITÉ DES FORMES POUR UN CONFORT OPTIMAL

Modernes et généreuses, les assises BIP offrent une assise enveloppante et confortable. Fixe ou pivotante, avec un large choix de piétements, BIP s'adapte autant aux espaces d'accueil, de détente que de réunion.





Points forts



Une assise pour chaque usage

Canapé ou fauteuil individuel



Une assise pour chaque espace

accueil, détente, réunion



Lignes arrondies et enveloppantes



Zooms



Pieds bois

avec pièce métal chromée



Roulettes

sol souple ou dur



Accoudoirs arrondis

avec surpiqûre contrastée



Tables basses SUZY p. 48

Nuancier spécifique

Tissu EVO Cat. A



TS
Noir

TH
Gris souris

Similicuir VALENCIA Cat. C



F2
Gris

F3
Noir

F4
Bleu marine

F5
Jaune maïs

F6
Vert Olive

F7
Terra cotta

F8
Grenat

F9
Beige

Tissu STEP Cat. B

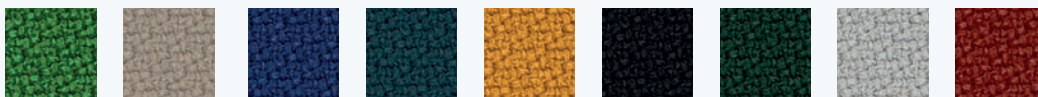

A1
Bambou

A2
Beige

A3
Bleu marine

A4
Bleu pétrole

A5
Jaune
moutarde

A6
Noir

A9
Vert anglais

E5
Gris clair

E6
Tomette

Synoptique

Piètement 4 pieds bois Piètement araignée Piètement central base ronde

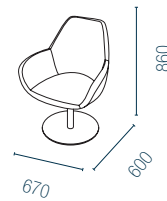
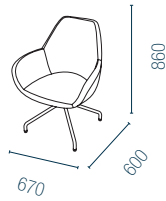
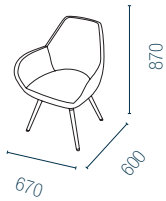

Piètement 4 branches Piètement 5 branches sur roulettes Placet d'assise

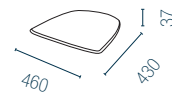
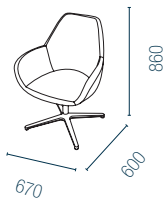

Piètement traineau 1 place Piètement traineau 2 places

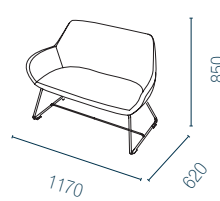
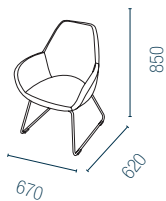

Tissu SYNERGY Cat. C



Q1
Beige clair chiné



Q2
Marron chiné

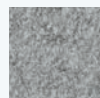

Q3
Gris smoke chiné



Q4
Gris anthracite chiné



Q6
Corail chiné

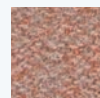

Q7
Saumon chiné



G1
Bleu foncé chiné



G3
Céladon foncé



G4
Vert d'eau



Surpiqûres blanches pour les coloris noirs (TS, A6, F3)
Surpiqûres noires pour tous les autres coloris.

TARIF P. 13
Détails et disponibilités
TOUTES LES RESSOURCES EN LIGNE





Tables Basses

TROUVEZ LA BONNE TABLE BASSE

Une offre large et variée qui s'adapte à une multitude d'espaces : du style classique, minimaliste au plus contemporain. En bois ou métal pour travailler ou simplement prendre un café, choisissez votre version !



Margot 

H. 35 x L. 100 x P. 50 cm

.....



H. 35 x L. 50 x P. 50 cm

.....



Zélie 

H. 43 x L. 90 x P. 50 cm

.....



H. 43 Ø67 cm

.....



H. 63 x L. 40 x P. 32 cm

.....



H. 63 x L. 56 x P. 34 cm

.....



Fabriqué
en France



PEFC
PEFC/07-32-197



Star

H. 45 x L. 60 x P. 60 cm



H. 48 Ø 60 cm



Évasion

H. 45 Ø 75 cm



TARIF P. 14
Détails et disponibilités
TOUTES LES RESSOURCES
EN LIGNE





Suzy

NOUVEAU

Assises CÔME p. 40

FONCTIONNELLE ET MODERNE

SUZY complète tous types d'aménagements grâce à ses nombreuses associations de coloris qui s'intègrent parfaitement aux environnements de travail contemporains. Modulable et pratique, elle s'adapte autant aux espaces d'accueil, qu'aux zones informelles des espaces de travail. Son utilisation en mode gigogne permet d'optimiser l'espace, de la reconfigurer à volonté et ne nécessite qu'un faible encombrement une fois rangée.

Synoptique

Plateau rectangulaire

H. 345 mm

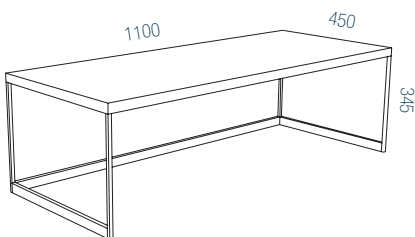

Plateau carré

H. 300 mm

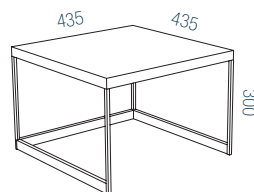

Fabriqué
en France





Points forts



Utilisation en gigogne

Ses deux formats de plateau de hauteurs complémentaires permettent une utilisation ingénieuse en gigogne.

Design contemporain

Piètement fin, plateau en cornière, choix des finitions : elle apporte une touche de modernité aux espaces de travail.

Multi-espaces

Des associations variées pour équiper autant les espaces d'accueil, bureau de direction, zones informelles que lounge.



Zooms



Plateau en cornière



Piètement tout en finesse

Nuancier

Bois/Métal

Plateau/Piètement



MGZO



R1ZO

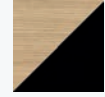

R1ZP



R9ZP



N5ZC



R6SC



R6Z9



R7ZG



R8Z8



N6SU

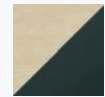

N8ST



R3ZP



RKZP

TARIF P. 14

Détails et disponibilités

TOUTES LES RESSOURCES
EN LIGNE





Greta

UNE BANQUE POUR CHAQUE ESPACE

Sa grande variété de modules et ses rangements complémentaires permettent à GRETA de s'adapter à toutes les typologies d'accueil. Décorative, ses panneaux frontaux et latéraux habillent les espaces avec élégance.

Fabriqué
en France



PEFC
PEFC/07-32-197





Sièges ELIOTT, p. 234 - Assises et tables basses MARGOT, p. 34/46

Fonctionnels, les plateaux et rangements disposent d'échancrure pour faciliter l'électrification des banques en toute discrétion.



Points forts



Panneaux décoratifs

Une base de structure en mélamine blanche qui vient s'agrémenter d'habillages frontaux (en option) ou latéraux. Habillages coordonnés aux plateaux.



Module PMR

Spécialement adapté aux personnes à mobilité réduite



Des rangements coordonnés

Avec top pré-percé pour obturateur (en option)

Avec porte coulissante + serrure intégrée

En option : tiroir pour dossiers suspendus



Zooms



Ergonomie utilisateur

Plateau avec échancrure pour intégration d'écrans jusqu'à 21 pouces



Habillage frontal

Avec tablette repose sac



Électrification discrète

Échancrure intégrée dans le bas des meubles de rangement



Sièges ELIOTT, p. 234

Options



Kit Led

Blanc ou couleur (à placer derrière l'habillage frontal)



Tiroir

Pour dossiers suspendus (en option)



Sièges ELIOTT, p. 234

Exemples de configurations

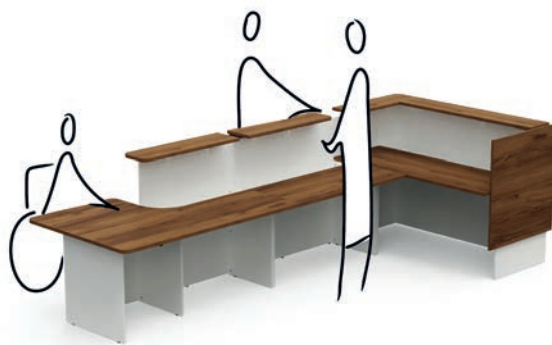

Recevoir du public des deux côtés

Avec un module d'angle et des habillages frontaux avec tablettes.

Modules hauts

Module d'angle

- Réception assis
- Plan de travail H. 73.5cm

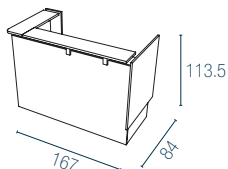

Module droits

- Réception assis
- Plan de travail H. 73.5cm
- Réception debout
- Plan de travail H. 95cm

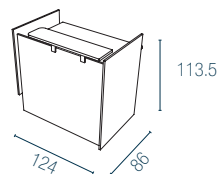
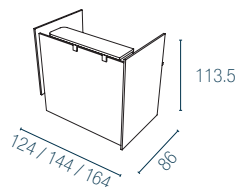

Modules PMR*

Réception assis / debout

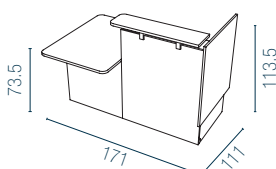

Réception assis

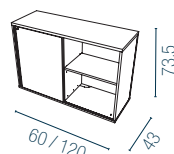
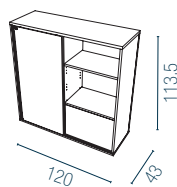
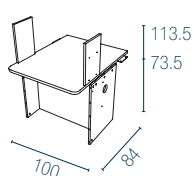

* PMR : Personne à Mobilité Réduite

Rangements

Options

Tiroir

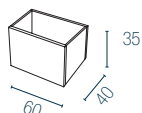

Tablette à poser ou à fixer

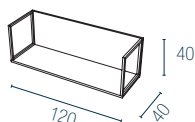

Habillage frontal

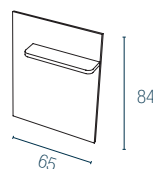

Nuancier

Mélamine

Structure banque ép. 25 mm
Corps des rangements ép. 19 mm



MG

Habillages frontaux ou latéraux ép. 19 mm



MG

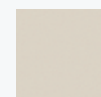

N5



R9



R6



N8*

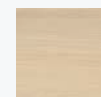

RZ



R1

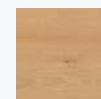

R5



R3

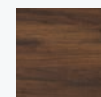

N6

* Chants multiplis

TARIF P. 15

Détails et disponibilités

TOUTES LES RESSOURCES EN LIGNE



Adaptée à tous publics

Intégrer un module PMR aux extrémités ou au centre de la banque permet de varier les postures d'accueil : assis ou debout.

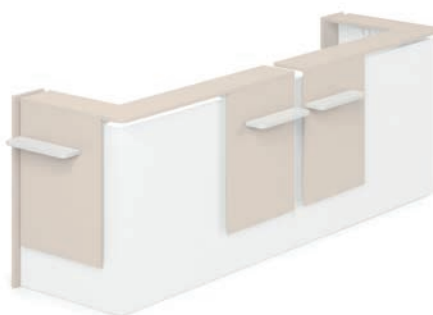

Garder un aspect confidentiel

Configurez votre accueil en banque fermée afin de garder un aspect confidentiel tout en montrant un espace rangé.



Guest

PERSONNALISEZ VOTRE ACCUEIL

GUEST est une banque d'accueil entièrement personnalisable.

Fabriqué
en France





Bureaux assis-debout LUTZ 2, p.110 - Sièges OSCAR 2, p. 228 - Assises ANOUK, p. 28 - Tables basses SUZY, p. 48 - Rangements GRETA, p. 50

Ses différents modules, son large choix de finitions et ses 4 décors de façades permettent à GUEST de créer des espaces d'accueil singuliers.



Points forts



Décorative

Une base de structure et piétement en mélamine blanche, qui accueillent des éléments décoratifs au choix



Une configuration pour chaque usage

4 modules aux choix à assembler selon ses besoins



Côté utilisateur optimisé

Pieds intermédiaires adaptés pour un meilleur confort des jambes



Habillages



Mélamine bois ou unis



Métal perforé « Biais »



Métal perforé « Feuilles »

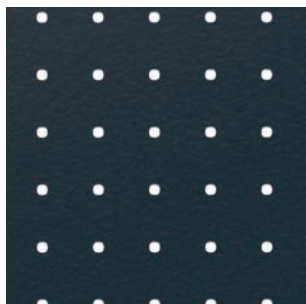

Métal perforé « Pois »



Éléments décoratifs

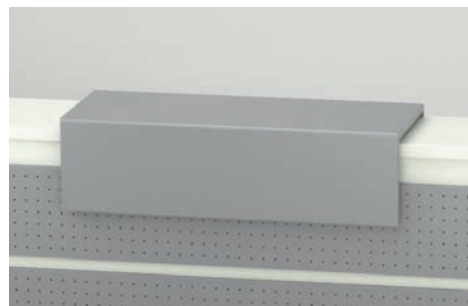

Sur-tablette en métal neutre



Sur-tablette en métal avec message + Option Kit Led blanc ou couleur



Assises MARGOT, p. 34

⌈ ⌋ Électrification



^
Obturbateurs de série
(sauf modules PMR)



^
Avec ou sans échancrure
Intégration d'écrans
jusqu'à 22 pouces



^
Goulotte métallique
pour passage de câbles
(en option)



**Exemples
de configurations**



Banque fermée

2 Modules d'angle droite et gauche, ajoutés à un module haut, offrent un aspect confidentiel à la banque d'accueil.



Banque ouverte

Intégrer un module PMR en extrémité ou au centre de la banque permet un accueil assis ou debout.

Modules

Modules haut

Plateaux standards -
2 obturateurs carrés intégrés

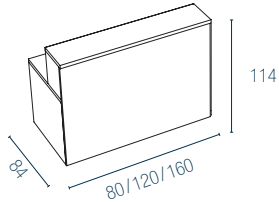

Plateaux avec échancrure –
Pré-perçés pour obturateurs optionnels

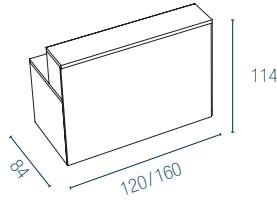

Modules d'angle

90° Droite ou Gauche

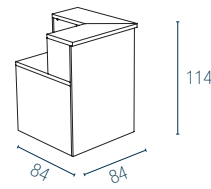

Modules PMR*

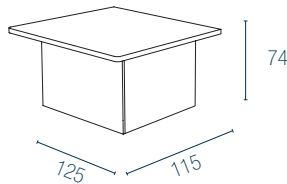
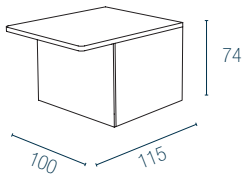

* PMR : Personne à Mobilité Réduite



Banque pour grand espace

Multiplier les modules pour de plus grands accueils

Nuancier

Mélanges

Plateaux ép. 30 mm



MG

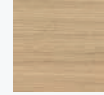

R1

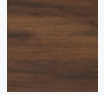

N6

Mélanges

Habillages ép. 19 mm



MG



N5



R9



R6

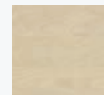

N8*

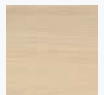

RZ

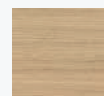

R1

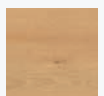

R5

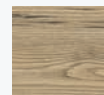

R3

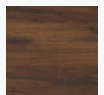

N6

* Chants multiplis

Métal

Habillages

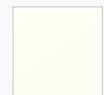

SO

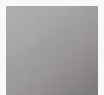

SA



SC



SG

TARIF P. 18

Détails et disponibilités

TOUTES LES RESSOURCES
EN LIGNE



Évasion

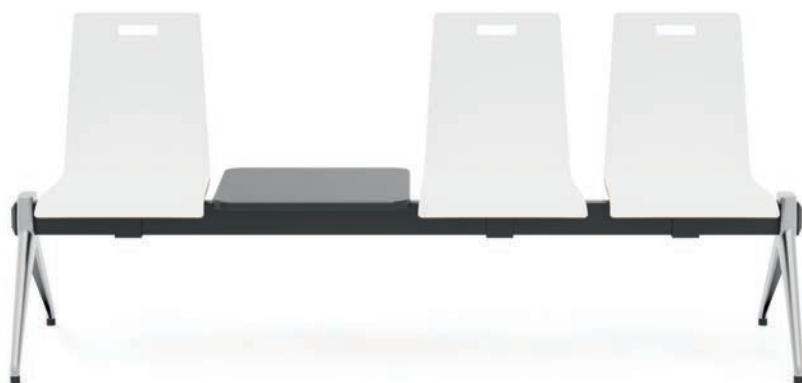

- ^ **Un design contemporain** avec des assises en hêtre multiplis
- ^ **Emplacement des assises et des tablettes au choix**
- ^ **Piètement aluminium brossé**
- ^ **Assise en retrait du pied** (évite les frottements contre le mur)

Nuancier

Hêtre multiplis

Assises



VK
Blanc



VM
Noir

Métal

Traverses



SB
Aluminium



SG
Noir

TARIF P. 21
Détails et disponibilités
TOUTES LES RESSOURCES
EN LIGNE



Fabriqué
en France



Rosalie



Assise enveloppante,
confortable et lavable

Emplacement des assises
et des tablettes au choix

Assise en retrait du pied
(évite les frottements contre le mur)

Fabriqué
en France



Sosi



Coque lavable
& résistante
(assise et dossier métallique)

Emplacement des assises
et des tablettes au choix

Fixation au sol disponible
sur demande
(nous consulter)



Nuancier

Polypropylène

Assises



PS
Blanc crème



PQ
Gris



PJ
Jaune



PR
Noir

Métal

Traverses



SB
Aluminium



SG
Noir

TARIF P. 21

Détails et disponibilités

TOUTES LES RESSOURCES
EN LIGNE



Nuancier

Métal

Traverses



SB
Aluminium



SG
Noir

TARIF P. 21

Détails et disponibilités

TOUTES LES RESSOURCES
EN LIGNE





Espaces de travail





Bureaux de Direction



Rio

Page 68 ›

.....



Kara NOUVEAU

Page 70 ›

.....



Robin NOUVEAU

Page 76 ›

.....



Karl

Page 80 ›

.....

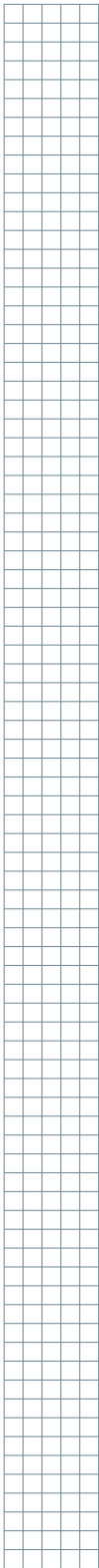



Rio

Sièges GABIN, p. 232 - Chaises ISABEL, p. 243

DES LIGNES INTEMPORELLES

Avec son esthétique sobre et moderne, RIO aménage les postes manager autant dans les espaces ouverts que les bureaux fermés. Dans sa version avec meuble retour, il offre un rangement sécurisé et facile d'accès.



Meuble retour porteur

Accès facile grâce au meuble légèrement rentrant



Porte coulissante sécurisée (à droite ou à gauche)



Électrification discrète

Carter à clipser sur le pied pour la descente des câbles

Fabriqué en France





Points forts



Élégance des espaces

Effet aérien grâce au plateau surélevé



Design intemporel

Piètement arche
Section rectangulaire (60 x 30 mm)



Personnalisable

Voile de fond (en option)



Électrification variée

Obturbateurs ou trappe



Synoptique

Bureaux individuels

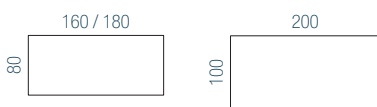

Bureaux avec meuble porteur

(Existe en version retour à droite ou à gauche)

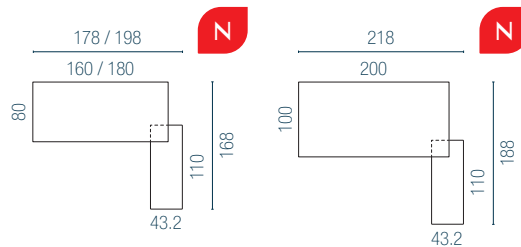

Retours

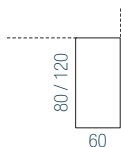

Tables de réunion

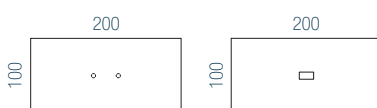

Connectique

Bureaux

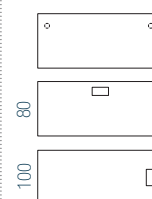

Nuancier

Mélamine

Plateaux ép. 25 mm



MG



N5



R9

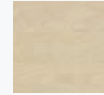

N8



RZ

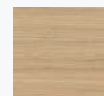

R1



R5

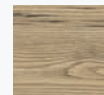

R3

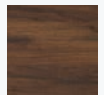

N6

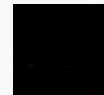

RK

Métal

Piètements

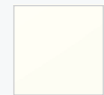

SO

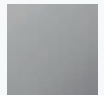

SA



SC



SG



Plus de choix disponibles

TARIF P. 24

Détails et disponibilités

TOUTES LES RESSOURCES EN LIGNE



Existe aussi en version Bureaux collaboratifs (CONECT) p. 90



Kara

NOUVEAU

OPTIMISER SA SURFACE DE TRAVAIL AVEC ÉLEGANCE

KARA se distingue par l'intemporalité de ses lignes. Ses différentes configurations offrent à la fois du rangement, une belle surface de travail et une électrification optimisée.

Fabriqué
en France





Sièges ATTITUD, p. 237 - Chaises LOUIS, p. 244 - Tables ELOISE, p. 210

Des rangements spécifiques coordonnés complètent l'ensemble pour un aménagement harmonieux. KARA, une gamme complète qui apporte du caractère à vos espaces de Direction.



Points forts



Statuaire & intemporel

Des formes droites, un plateau épais qui donne du caractère aux espaces de direction



Complète et variée

Des configurations multiples complétées par des rangements coordonnés



Électrification discrète et optimisée

Obturbateurs et/ou trappe électrifiée



Zooms



Entretoise entre le plateau et le pied

En coloris noir, elle apporte singularité au bureau



Gestion horizontale des câbles

Goulotte en métal noir L.120 cm à fixer sous le plan principal et/ou le plan retour



Gestion verticale des câbles

Carter amovible H. 55 cm en métal noir à positionner dans le piètement



Sièges SEVEN, p. 238 - Lampadaires CL09, p. 272 - Lampes CHAMPI p. 272



^
Caisson 3 tiroirs

Ouverture sélective des tiroirs
Fermeture sécurisée
Poignées en métal noir



^
Plan retour

Pré-perçages obturateurs
Possibilité d'ajouter une goulotte
et un carter (coloris noir)



^
Meuble de rangement retour

1 porte coulissante sécurisée
2 niches et 3 tiroirs fermés dont
1 pour dossiers suspendus



Sièges et chaises SEVEN, p. 238 - Lampes CHAMPI p. 272

Des configurations variées



Avec un caisson 3 tiroirs pour offrir un rangement sécurisé



Avec un retour simple pour agrandir sa surface de travail



Avec un meuble retour intégrant un rangement de proximité et une surface de travail optimisée

Bureaux

Le caisson 3 tiroirs, le retour porteur et le meuble de rangement se positionnent à droite ou à gauche du plan principal.

Bureaux individuels

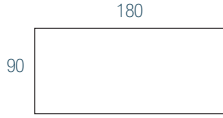

Bureaux avec caisson 3 tiroirs

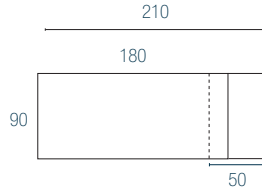

Connectique

Plan principal

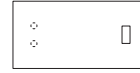

(Inclus goulotte et carter)

Bureaux avec retour

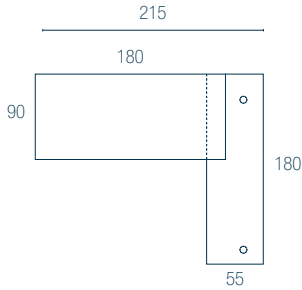

Bureaux avec retour et caisson 3 tiroirs

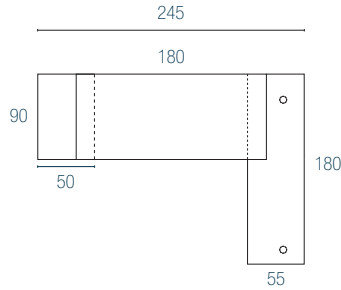

Bureaux avec meuble de rangement

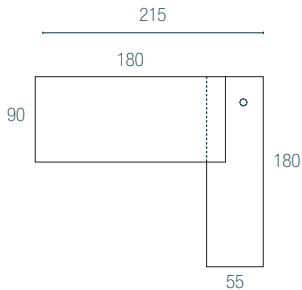

Bureaux avec meuble de rangement et caisson 3 tiroirs

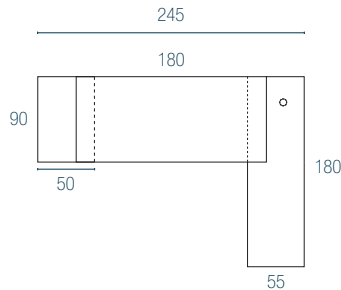

Rangements

Armoires 2 portes coulissantes sécurisées avec ou sans niches (1 niche = 1 hauteur classeur).
Fond coloris noir.

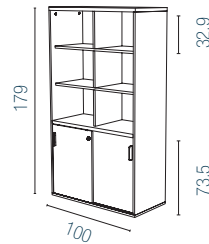
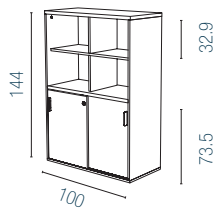
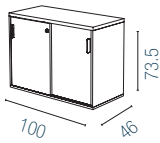

Nuancier

Mélamine

Plateaux et piétements ép. 30 mm, caisson, retour, meuble de rangement et armoires

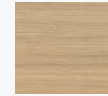

R1

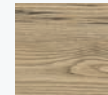

R3

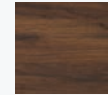

N6

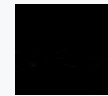

RK



Encore plus de possibilités de rangement
Cf. MELINA p.132

TARIF P. 26

Détails et disponibilités

TOUTES LES RESSOURCES
EN LIGNE





Robin

NOUVEAU

DES LIGNES DOUCES ET MODERNES

Inspiré des codes de l'habitat, ROBIN se distingue par l'élégance de ses pieds en bois massif. Légèrement arrondis, ils apportent douceur et chaleur aux environnements de travail avec une touche de modernité.

Fabriqué
en France





Sièges ATTITUD, p. 237 - Chaises SCOTT, p. 250 - Rangements GRETA, p. 50 - Lampes AVA p. 272

ROBIN offre des solutions variées pour répondre aux différents usages. Disponible en bureau simple ou grand format pour recevoir les collaborateurs, avec ou sans rangement, il est le partenaire idéal pour aménager vos espaces de travail.



Sièges ATTITUD, p. 237 - Chaises LOUIS, p. 244 - Lampes CHAMPI p. 272

2 positions pour le meuble



^
Débordant



^
Aligné

Option



^
Tiroir pour dossiers suspendus

Façade mélamine
Ouverture par pression



Points forts



Elégance et modernité des lignes

Pieds en hêtre massif aux lignes arrondies réhaussés d'une platine discrète en métal

Rangement sécurisé

Porte coulissante avec fermeture à clé

Électrification optimisée

Obtrateurs ou trappe.
Passe câbles intégré dans le rangement porteur

Synoptique

Bureaux individuels

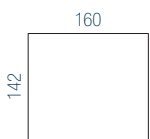
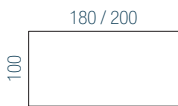

Bureaux avec meuble porteur

(à positionner à droite ou à gauche)

Aligné

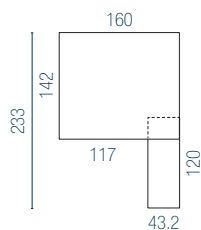
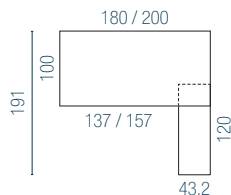

Débordant

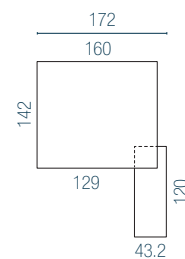
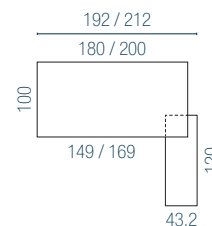

Connectique

Bureaux P. 100

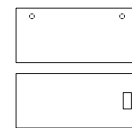

Bureaux P. 142

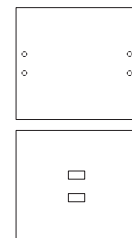

Nuancier

Mélamine

Plateaux ép. 25 mm, corps des rangements. (Porte coulissante assortie au plateau)



MG

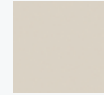

N5



R9

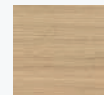

R1

Métal

Platine pieds (Poignée porte assortie)

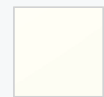

SO

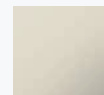

ZC



SG

Bois massif

Pieds



MS

TARIF P. 30

Détails et disponibilités

TOUTES LES RESSOURCES EN LIGNE



Existe aussi en version Bureaux collaboratifs p.100 et en version Réunion p.170



Karl

ÉLÉGANCE ET CARACTÈRE DES ESPACES DÉCISIONNELS !

KARL se distingue par l'élégance de son dessin et la noblesse de ses matériaux. Son pied en chêne massif associé aux différents coloris de plateaux impose un style singulier aux espaces de direction.

Fabriqué
en France





Sièges LEON, p. 230 - Chaises SCOTT, p. 250 - Lampes CHAMPI p. 272

Pour accueillir ses collaborateurs et échanger, il est possible d'ajouter une table de réunion carrée. KARL transforme votre espace en un lieu soigné et raffiné grâce à ses rangements ouverts et fermés, parfaitement adaptés à vos besoins.



Sièges LEON, p. 230 - Lampes CHAMPI p. 272

Zooms



^ Pied électrifié

Passage de câbles intégré au piétement (pour les versions plateaux avec trappe)



^ Trappe soft closing

Dessus des trappes coordonné au plateau (excepté RK trappe coloris noir)

Option



^ Tiroir en métal

Compartimenté et sécurisé



Points forts



↑ Élégance des espaces

Des formes douces alliées à des matières nobles (pieds et poignées en chêne massif)

↑ Meubles coordonnés

Au choix, crédences ou bibliothèques disponibles dans différents formats

↑ Personnalisable

Voile de fond et tiroir métalliques (en option)

Synoptique

Bureaux individuels

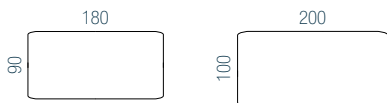

Connectique Bureaux

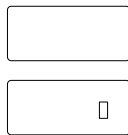

Tables

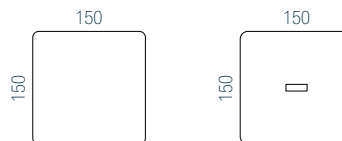

Rangements

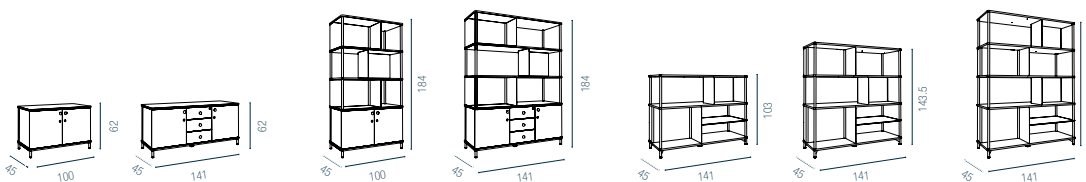

Nuancier

Bureaux / Tables

Mélamine

Plateaux ép. 19 mm

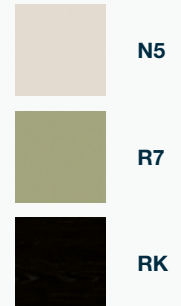

Métal / Bois Massif

Structure / Piétement



Rangements

Mélamine

Top et tablettes ép. 19 mm



Mélamine / Métal

Corps / Structure, séparateurs, portes et tiroirs



TARIF P. 31

Détails et disponibilités

TOUTES LES RESSOURCES EN LIGNE



KARL existe aussi en version réunion p. 172

Bureaux collaborateurs & séparations



Ariel

Page 86 ›

.....



Conect

Page 90 ›

.....



4 Line

Page 96 ›

.....



Robin NOUVEAU

Page 100 ›

.....



Forstyl

Page 104 ›

.....



Idol

Page 106 ›

.....



Lutz 2

Page 110 ›

.....



Axel 2

Page 114 ›

.....



Twins

Page 120 ›

.....



Solange

Page 122 ›

.....



Découvrez nos conseils pour adopter une bonne posture au bureau en flashant ce QR Code





Arial

RENDRE L'ESPACE AGILE

Dotés de formes intemporelles et d'un large choix, les bureaux ARIAL s'adaptent autant aux espaces de travail, de réunion que de formation.

Fabriqué
en France



Uniquement pour les bureaux fixes (sans roulettes)
et RH plateaux ép. 25 mm - Hors finition R9



Sièges OSCAR 2, p. 228 - Cloisons et écrans SOLANGE, p. 122 - Tableau mobile MARTIN p. 192

Sa version mobile apporte de l'agilité aux environnements de travail. Elle permet aux collaborateurs de choisir la configuration la mieux adaptée à leurs usages sans changer de pièce.



Sièges LEON, p. 230 - Cloisons et écrans SOLANGE, p. 122 - Tower GUSTAVE, p. 138 - Rehausses, p. 135

2 types de piétements



^ Arche

Pour bureau individuel
et structure partagée
FIXE H. 73,5 cm
RH 62 à 86 cm



^ Arche mobile

Pour bureau individuel
FIXE H. 73,5 cm
(Roulettes noires avec frein,
tous types de sols)

Option



^ Carter aimanté à clipser

Permet la descente des câbles



Points forts



Design Minimaliste

Des lignes simples
Piétement arche section carrée (50x50 / 45x45 mm)



Polyvalente

Un synoptique varié pour équiper autant les espaces de travail que les espaces réunion ou formation (cf. ARIAL réunion p. 164)



Électrification variée

Obtrateurs, échancrure ou trappe



Synoptique

Bureaux individuels



d Existe en version mobile

Plateaux ép. 19 mm uniquement pour bureaux P. 80 x 140/160 cm

Bureaux structure partagée

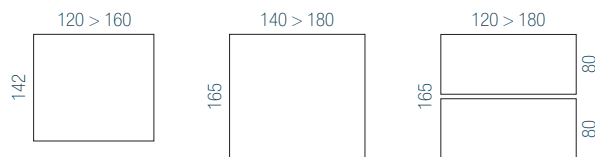

Retours

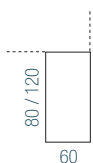

ARIAL existe aussi en version Réunion p.164

Nuancier

Mélanges

Plateaux ép. 19 mm* ou 25 mm



MG



N5



R9

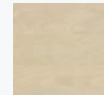

N8



RZ

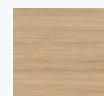

R1

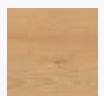

R5

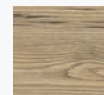

R3

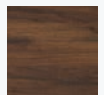

N6

* Les plateaux ép. 19 mm sont disponibles avec les finitions R1 et MG uniquement

Métal

Piétements



SO

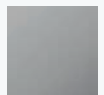

SA



SC



SG



Plus de choix disponibles

Connectique



Ép. 19 mm



Ép. 25 mm

TARIF P. 34

Détails et disponibilités

TOUTES LES RESSOURCES EN LIGNE





Conect

L'ALLIÉ DES BUREAUX PARTAGÉS

Un piétement arche aux lignes épurées, un plateau légèrement surélevé pour un design plus aérien... CONECT apporte de la légèreté aux espaces de travail.

Fabriqué
en France



PEFC
PEFC/07-32-197



AMEUBLEMENT
certifié responsable
Hors finition R9





Sièges ELIOTT, p. 234 - Ecrans SOLANGE, p. 122 - Table haute ELISA p. 214 - Assises et tables basses ZELIE, p. 22/46 - Casiers CAMILLE, p. 146

Sa structure monobloc en fait aussi l'allié des bureaux partagés. Avec son système de bureaux départ et suivant, CONECT se multiplie à l'infini en fonction de l'espace disponible et de la population à équiper.



Points forts



Design intemporel

Piètement arche mono bloc.
Section rectangulaire
(60 x 30 mm)



Élégance des espaces

Plateau surélevé du piètement
pour un effet aérien



Électrification variée

Obturbateurs, échancrure ou trappe



2 types de piétements arche



Fixe

H. 73,5 cm



Réglable en hauteur

H. 62 à 86 cm



Option



Carter à clipser sur le pied

Permet la descente des câbles



Sièges ELIOTT, p. 234 - Cloisons & Ecrans SOLANGE, p. 122 - Assises et tables basses ZELIE, p. 22/46 - Rangements JAMES, p. 140 - Lampadaire NEO, p. 272 - Lampe CL02, p. 272.



Sièges GABIN, p. 232 - Ecrans SOLANGE, p. 122

Exemples de configurations



Travailler

Optimiser sa surface en optant pour un caisson porteur sous le retour



Ranger

Positionné à droite ou à gauche, en version simple ou double accès, le meuble de proximité offre à la fois, un rangement et un plan retour.

Synoptique

Bureaux individuels

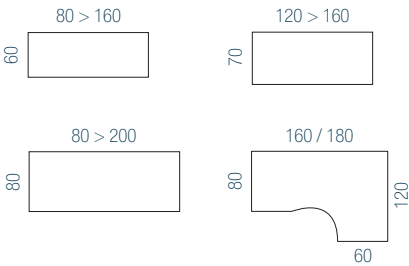

Bureaux avec rangement

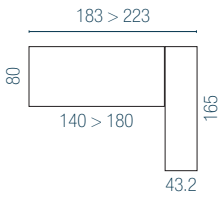

Bureaux structure partagée

Existe en plateaux fixes et coulissants

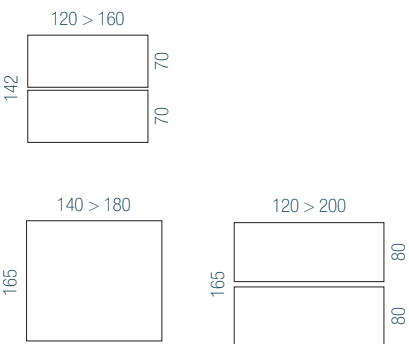

Bureaux avec rangement

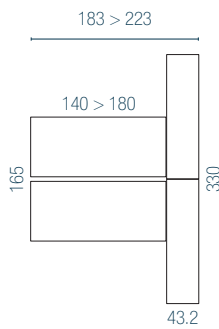

Retours et extensions

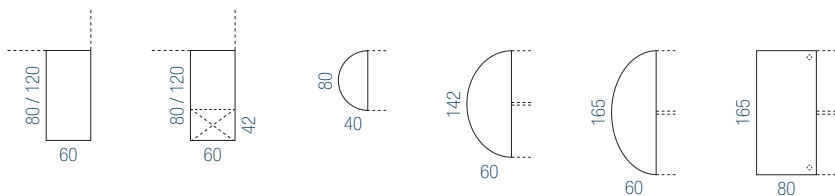

Connectique

Diagrams showing different connector types for desk assembly.

Nuancier

Mélamine
Plateaux ép. 25 mm

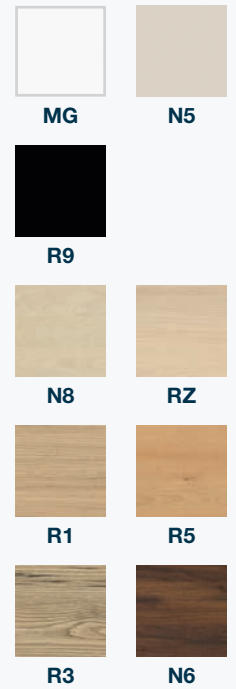

Métal

Piètements

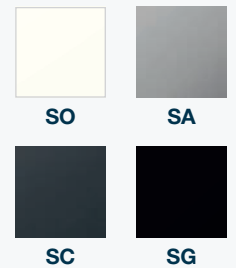

Plus de choix disponibles

TARIF P. 36

Détails et disponibilités

TOUTES LES RESSOURCES EN LIGNE



Travailler en équipe

En pôle de 2, 4 et plus, CONECT structure les espaces de travail en permettant l'échange et la concentration



Se réunir

En version monoplateau avec une extension, le bureau structure partagée offre une belle surface de travail



4 Line

ASTUCIEUSE & ESTHÉTIQUE

4 LINE offre des solutions d'aménagement simples et efficaces. Dotés d'un pied fuselé triangulaire associé à un plateau aux coins arrondis, les bureaux 4 LINE apportent modernité et esthétique à vos espaces de travail.

Fabriqué
en France





Sièges GABIN, p. 232 - Cloisons & Ecrans SOLANGE, p. 122 - Chaises SCOTT, p. 250 - Armoires ARMAND, p. 142

Grâce à son pied avec carter amovible pour la descente des câbles, 4 LINE offre une électrification discrète et esthétique. La version pied partagé permet de réunir 2 plateaux et ainsi réduire le nombre de pieds pour apporter légèreté à l'ensemble.



Sièges GABIN, p. 232 - Ecrans SOLANGE, p. 122 - Tower LEO, p. 136

3 types de piétements



^
Pieds fixes
H. 74 cm



^
Pieds fixes électrifiables
H. 74 cm
Carter amovible permettant
la descente des câbles



^
**Pieds réglables en hauteur
électrifiables**
H. 64 à 86 cm avec carter amovible



Points forts



^ Multiples configurations

En bureaux individuels ou pôles de 2, 3, 4, et plus grâce aux pieds partagés. Différents formats de plateaux.

^ Personnalisable

Grâce aux plans retours et caissons à ajouter pour augmenter sa surface de travail et ranger.

^ Électrification optimale

Gestion horizontale (obturbateurs ou trappes) et verticale des câbles (carter amovible dans le pied).

□ Synoptique

Bureaux individuels

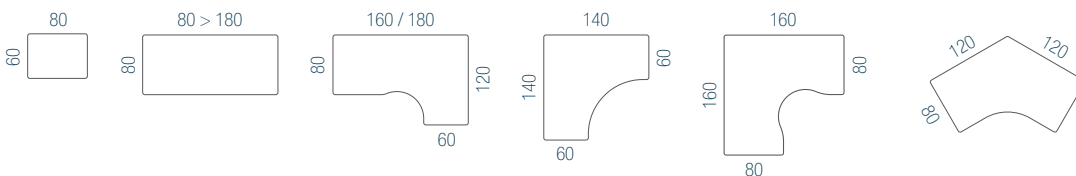

Bureaux pieds partagés

Départ

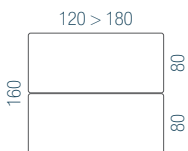

Suivant

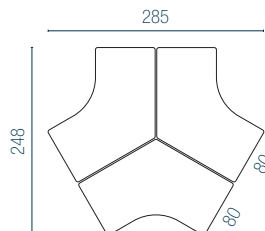
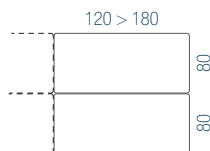

Connectique



Goulotte structurelle incluse L. 160 et 180 cm



Goulotte incluse toutes longueurs

Retours

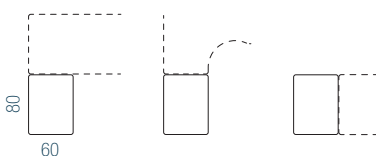

Caissons

Top mélamine

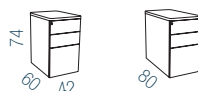

Réunion

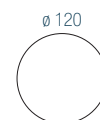

Nuancier

Mélamine

Plateaux ép. 30 mm, top caissons

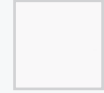

MG

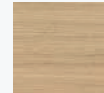

R1



R3

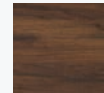

N6

Métal

Piètements, caissons



SO



SA



SC



SG



Plus de choix disponibles

TARIF P. 40

Détails et disponibilités

TOUTES LES RESSOURCES EN LIGNE





Robin

NOUVEAU

DES LIGNES DOUCES ET MODERNES

Inspiré des codes de l'habitat, ROBIN se distingue par l'élégance de ses pieds en bois massif. Légèrement arrondis, ils apportent douceur et chaleur aux environnements de travail avec une touche de modernité.

Fabriqué
en France





Sièges ELIOTT, p. 234 - Ecrans SOLANGE, p. 122 - Tabourets SOFIA p. 264 - Cabine CHATBOX, p. 198 - Casiers CAMILLE, p. 146

ROBIN offre des solutions complètes et variées pour équiper autant les espaces manager, que les espaces collaboratifs ou de réunion. Grâce à son pied unique pour toutes les configurations, il apporte une harmonie globale aux aménagements.



Sièges de Direction ATTITUD, p. 237 - Sièges OSCAR 2, p. 228 - Ecrans SOLANGE, p. 122 - Poufs Zélie, p. 22 - Lampe AVA, p. 272

Zooms



^ **Pied en bois massif**

Pied en hêtre massif réhaussé d'une platine discrète en métal



^ **En version pied partagé**

Il permet de réunir 2 plateaux, en version départ/suivant ou pour les retours et extensions



Points forts



Élégance et modernité des lignes

Pieds en bois massif aux lignes arrondies pour apporter douceur aux espaces de travail



Polyvalence

Existe en différents formats et dimensions : bureaux individuels ou partagés, avec retour ou extension.



Électrification variée

Obturbateurs ou trappe



Synoptique

Bureaux individuels



Bureaux structure partagée

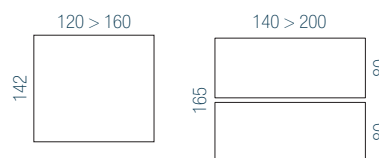

Retours et extensions

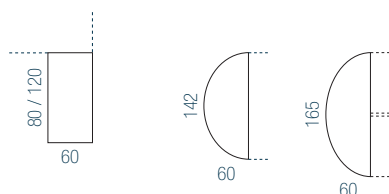

Connectique

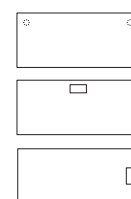

Uniquement plateaux P. 100

Nuancier

Mélangé

Plateaux ép. 25 mm

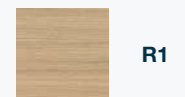

Métal

Platine pieds

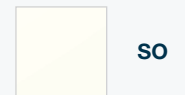

Bois massif

Pieds



TARIF P. 44

Détails et disponibilités

TOUTES LES RESSOURCES EN LIGNE



ROBIN existe aussi en version Manager p.76 et en version Réunion p.170



Forstyl

Sièges OSCAR 2, p. 228 - Lampe AURA, p. 272

Zooms



Bureau H. 73.5 cm

Entretoises grises entre le plateau et le pied panneau pour un effet plus aérien



Meuble retour compact

2 portes coulissantes sécurisées, 1 niche. Poignées métal grises

Fabriqué en France



PEFC
PEFC/07-32-197



Points forts



Nuancier

Mélangé

Plateaux, pieds
panneaux et voile
de fond ép. 25 mm

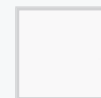

MG

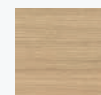

R1

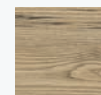

R3

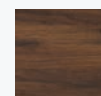

N6

Métal

Pied de soutien des
extensions, poignées

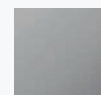

SA



Des finitions simples

Bureau unicolore relevé
par quelques éléments gris



Variété des formats

Bureaux simples ou avec meuble
de rangement. Plateaux droits
et arqués



Électrification optimisée

Plateaux pré-perçés
pour obturateurs (en option)
Voile de fond percé des 2 côtés
pour permettre le passage
des câbles.



Synoptique

Bureaux individuels

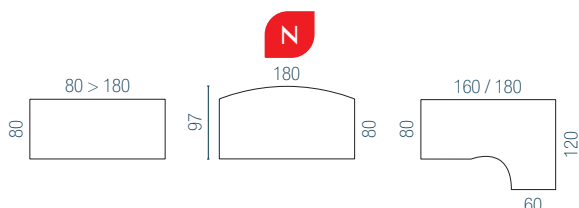

Bureaux avec rangement porteur

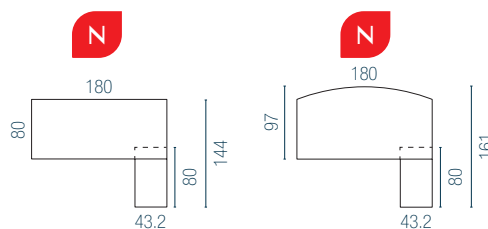

Retours et extensions

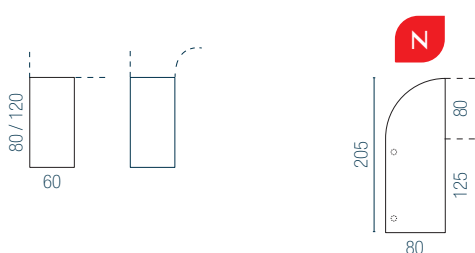

Connectique



TARIF P. 46

Détails et disponibilités

TOUTES LES RESSOURCES
EN LIGNE





Idol

Sièges GABIN, p. 232 - Ecrans SOLANGE, p. 122 - Caissons métal, p. 130

POLYVALENCE DES AMÉNAGEMENTS

Grâce à ses différents pieds et sa variété de plateaux, IDOL est la solution pour répondre aux différents aménagements. En version pied centré ou décentré, le pied IDOL offre une grande liberté de mouvement des jambes. En plus, son carter clipsable, apporte une touche décorative en même temps qu'il masque l'électrification verticale du bureau.

Fabriqué
en France





Points forts



Variété des pieds

Centré ou décentré pour ne pas gêner le mouvement des jambes sous le plateau



Choix des plateaux

Plans droits, compacts asymétriques ou symétriques, pour des configurations multiples



2 modèles de structure

Traverse ou voile de fond structurel



3 types de piétements



Centré fixe

H. 73.5 cm
Avec ou sans carter



Décentré fixe

H. 73.5 cm
Avec ou sans carter



Centré réglable en hauteur

H. 62 à 86 cm
Carter inclus



Sièges LEON, p. 230 - Ecrans SOLANGE, p. 122 - Pouf ZELIE, p. 22

 **Multiples
configurations**



Augmenter sa surface de travail grâce aux retours et extensions



Changer le pied pour un caisson porteur pour offrir du rangement



Une configuration trio pour un espace confortable et convivial

Synoptique

Bureaux individuels

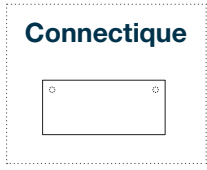
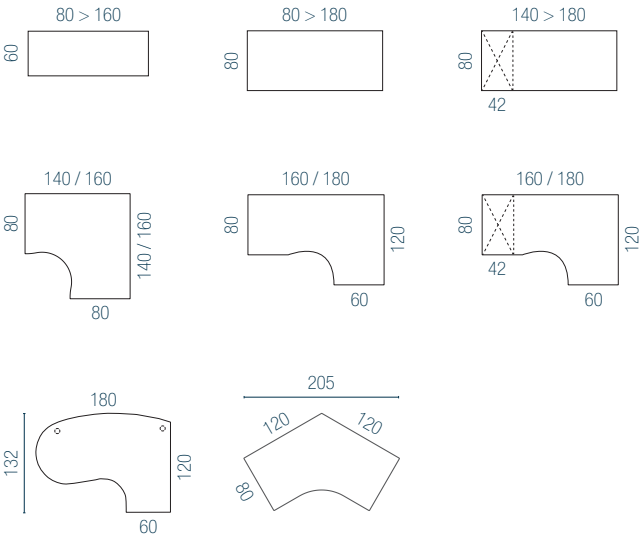

Retours & extensions

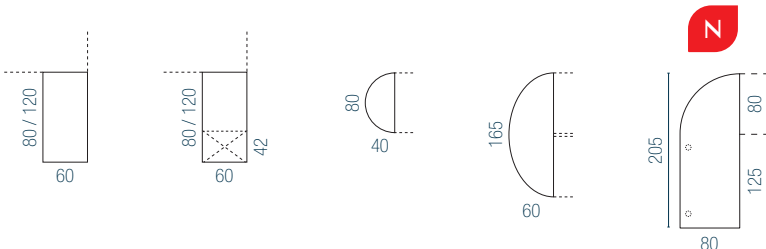

Zooms



Carter décoratif
Il masque la descente des câbles











Voile de fond
Structural pour pied décentré ou en option pour pied centré

Nuancier



Mélanges

Plateaux ép. 25 mm

-  **MG**
-  **N5**
-  **N8**
-  **RZ**
-  **R1**
-  **R5**
-  **R3**
-  **N6**

Métal

Piètements, carters

-  **SO**
-  **SA**
-  **SC**

TARIF P. 47
↓
Détails et disponibilités

TOUTES LES RESSOURCES EN LIGNE
↓





Lutz 2

LE POSTE ASSIS-DEBOUT ACCESSIBLE

Une offre de bureaux individuels avec système motorisé à prix économique, pour alterner les postures et lutter contre la sédentarité.





Sièges OPUS, p. 233 - Ecrans SOLANGE, p. 122 - Assises ANOUK, p. 28 - Tables basses ZELIE, p.46 - Caissons métal, p. 130 - Lampadaire CL05, p. 272

Pratique, son boîtier de commande à mémoires de position offre également un accès direct à un port USB chargeur A+C. Il intègre également une alarme pour rappeler à l'utilisateur de se lever.



Sièges ELIOTT, p. 234 - Casiers CAMILLE p. 146

Zoom



^ **Réglage motorisé**

Ajustable H. 71.5 à 117.5 cm
4 mémoires de position
1 USB chargeur (A+C) intégré
Alarme de rappel pour se lever

Options



^ **Roulettes discrètes**

Avec frein ø 40 mm
(tous types de sols)



^ **Vertèbre extensible**



Points forts



Esthétique

Embase arrondie avec vérins ajustables

Sécurisant

Système anti-collision intégré

1 moteur

2 bras télescopiques, section carrée

Électrification variée

Obturbateurs, échancrure ou trappe



Option



Carter aimanté



Synoptique

Plateaux ép. 19 mm



Plateaux ép. 25 mm



Connectique



Ép. 19 mm



Ép. 25 mm

Nuancier

Mélanges

Plateaux ép. 19 mm* ou 25 mm



MG



N5



R9

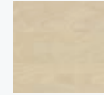

N8



RZ

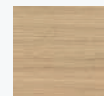

R1



R5

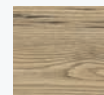

R3

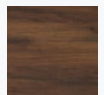

N6

* Les plateaux ép. 19 mm sont disponibles avec les finitions R1 et MG uniquement

Métal

Piètements

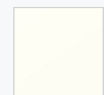

SO

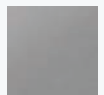

Z4



SG

TARIF P. 50

Détails et disponibilités

TOUTES LES RESSOURCES EN LIGNE





Axel 2

LE BUREAU QUI VOUS VEUT DU BIEN

AXEL 2 participe directement au bien-être des collaborateurs en permettant à son utilisateur d'alterner les postures entre travail assis ou debout, prévenant ainsi la sédentarité au travail. En espace de travail individuel, collectif ou de réunion, AXEL 2 offre une solution ergonomique adaptée.





Sièges OSCAR 2, p. 228 - Tableau mobile MARTIN, p. 192 - Table NOMAD, p. 186

Disponible en version électrique ou manivelle, AXEL 2 apporte une offre complète de bureaux et tables de réunion conçue pour s'adapter à chaque situation et encourager le mouvement tout au long de la journée de travail.



Sièges OPUS, p. 233 - Ecrans SOLANGE, p. 122 - Assises MARGOT p. 34 - Armoires ARMAND, p. 142

Options



Mobile

Roulettes discrètes avec frein \varnothing 40 mm (tous types de sols). Vérins de mise à niveau en version fixe



Panneaux écrans tissu

Acoustiques ou non acoustiques



Électrification facilitée

Montée de câbles (Vertèbre extensible ou carter aimanté). Goulotte intégrée pour les bureaux structure partagée



Points forts



Multi espaces

Un synoptique varié pour équiper autant les open spaces en bureaux que les espaces réunion



Sécurisant

Système anti-collision intégré (pour la version motorisée)



Système motorisé performant

Double motorisation (3 bras télescopiques / colonne)



Personnalisable

Gestion variée de l'électrification
Possibilité d'ajouter des écrans de séparation



Choisir son type de réglage



Réglage par manivelle

Ajustable H. 71.5 à 115.5 cm
Manivelle rétractable sous plateau
Pied gradué au pas de 1 cm



Réglage motorisé

Ajustable H. 65 à 130 cm
2 mémoires de position / personne (jusqu'à 4 utilisateurs)
1 USB chargeur (A+C) intégré
Alarme de rappel pour se lever



Sièges LEON, p. 230 - Ecrans SOLANGE, p. 122

Exemples de configurations



Bureau individuel

Positionné en vis à vis ou seul, AXEL 2 permet à chaque collaborateur d'alterner les postures.



Bureau avec retour

Pour une surface de travail optimisée, les bureaux AXEL 2 offrent une zone de travail principale et une zone complémentaire.

Synoptique

Bureaux individuels

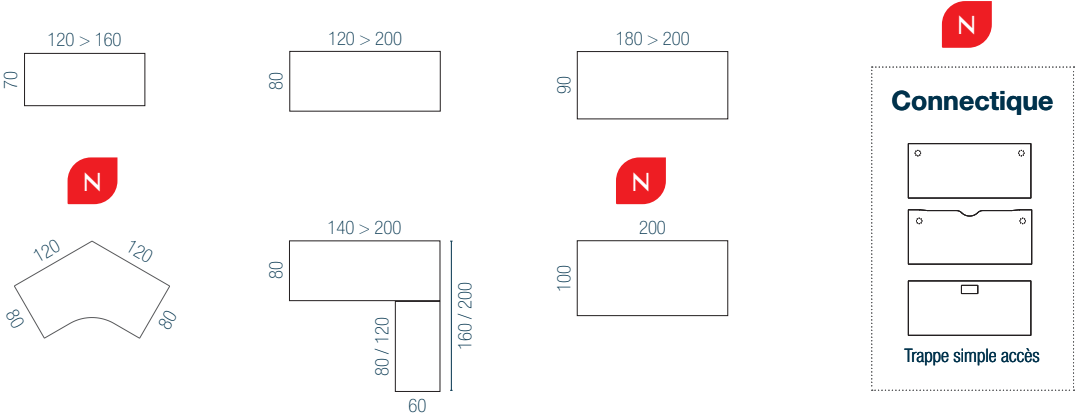

Bureaux structure partagée

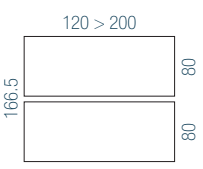

Panneaux écrans



Pour les bureaux individuels, retrouvez les offres du catalogue, SOLANGE et TWINS p. 120 et 122.

Tables de réunion

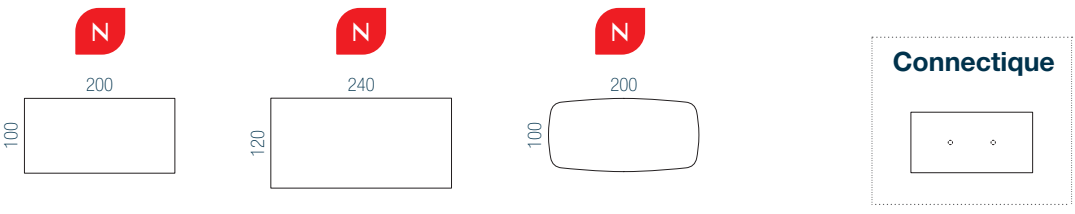

Bureau partagé

La version duo permet d'équiper les open spaces et d'encourager la communication des collaborateurs tout en laissant le choix de la hauteur du plateau.



En réunion

Au choix plusieurs dimensions et formats de tables pour alterner les postures et dynamiser les échanges.

Nuancier

Mélamine
Plateaux ép. 25 mm

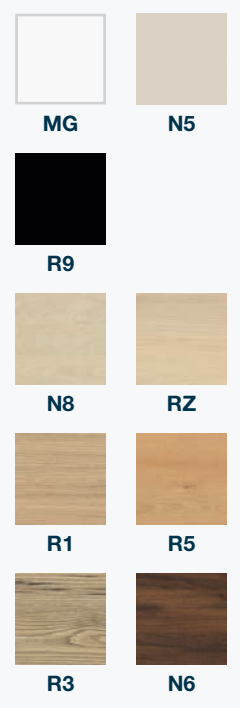

Métal
Piétements

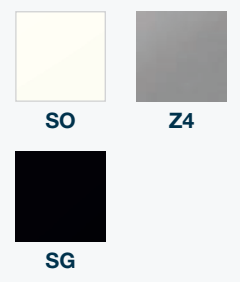

Tissu

- Écrans
- Cat. A**
BONDAÏ
 - Cat. B**
STEP
STEP MÉLANGE
CHILI
 - Cat. D**
FENICE
CYBER
(uniquement écrans
acoustiques)

TARIF P. 51
↓
Détails et disponibilités

**TOUTES LES RESSOURCES
EN LIGNE**
↓





Twins

Bureaux ARIAL, p. 86 - Caissons métal, p. 130

PERSONNALISABLE ET ABORDABLE

Une gamme de panneaux écrans plus économique, alliant durabilité et esthétique grâce à leur conception en mélamine ou tissu. Twins offre une solution élégante et abordable pour des espaces personnalisés.

Fabriqué
en France



PEFC
PEFC/07-32-197





Points forts



Recyclé

Panneaux issus de chutes ou de panneaux déclassés (pour les versions tissu)



Pratique

Accessoires à poser sur un rail (bacs à courrier et pot à crayons)



Choix des matières

Mélamine ou tissu



Synoptique

Panneaux écrans

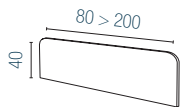

Cloisons

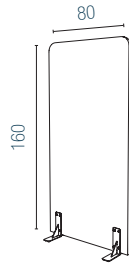

Pinces de fixation - Compatibles avec plateaux ép. 19 à 30 mm



Fixation frontale postes individuels

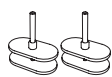

Fixation double postes vis-à-vis ou bench



Fixation traversante pour bench mono plateau

Nuancier

Mélamine

Écrans ép. 19 mm, cloisons ép. 25 mm



MG



N5



R9

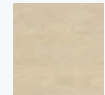

N8



RZ

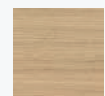

R1

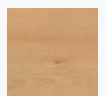

R5

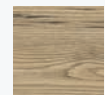

R3

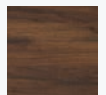

N6

Tissu

Écrans & cloisons ép. 25 mm



Cat. A
BONDAÏ



Cat. B
STEP
STEP MÉLANGE
CHILI



Cat. D
FENICE

Métal

Pinces, pieds, rails, accessoires



SO

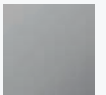

SA



SC



SG

TARIF P. 56

Détails et disponibilités

TOUTES LES RESSOURCES
EN LIGNE





Solange

À CHACUN SON ESPACE

Caractérisée par des lignes douces, SOLANGE transforme avec élégance les espaces partagés en espaces privés propices à la concentration.

Fabriqué
en France

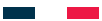



Bureaux CONECT, p. 90 - Sièges LEON, p. 230

Son ingénieux système de liaison, sans outil, permet de combiner plusieurs écrans ou cloisons entre eux. Ainsi les espaces se reconfigurent à l'envi.



Points forts

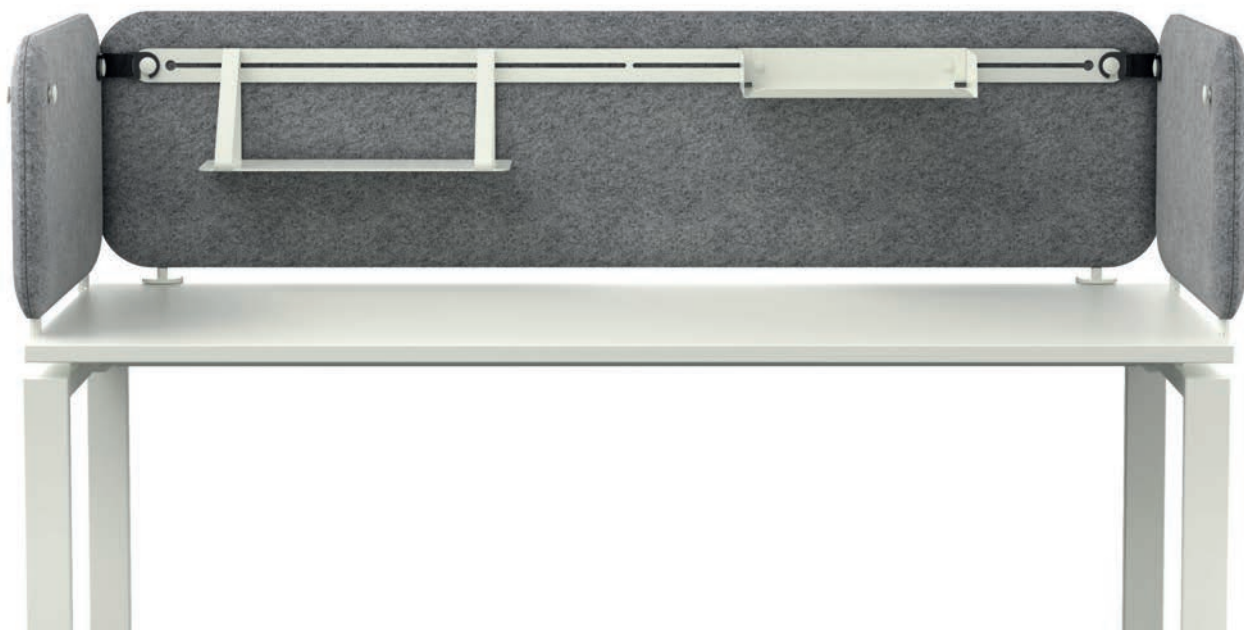

Un écran pour chaque usage

Version frontale ou latérale.
À poser ou à fixer



Pratique

Accessoires facilement
repositionnables



Acoustique

Environ 50 %
des nuisances sonores
absorbées



Recyclé et durable

Âme en mousse de matelas
recyclée pour les panneaux
écrans H. 40 et 50 cm



Zooms

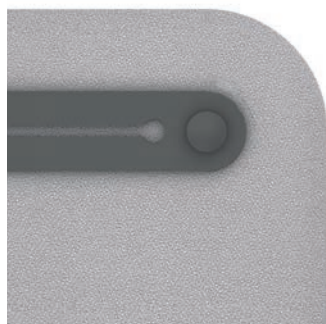

Boutons

Esthétiques et fonctionnels, pour intégration
d'un rail porte-accessoires

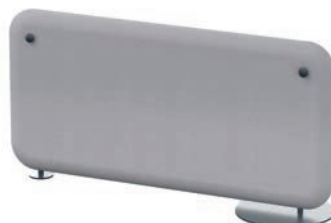

Version à poser

L'écran se pose et se dépose à volonté
grâce au jeu de pieds



Points forts



Astucieux

Un seul kit de liaison pour relier 2, 3 ou 4 cloisons, sans outils



Douceur des angles

Pour un style contemporain



Fixe ou mobile

(Roulettes tous types de sols)



Varié

Acoustique ou non acoustique



Options



Kit de liaison

Pour relier cloisons ou panneaux écran



Tableau écritoire

Avec plumier
Se pose sur les cloisons





↗
**Exemples
de configurations**



^
Libérer sa surface de travail

Des accessoires pour personnaliser l'espace de chaque collaborateur



^
 La version panneau écran H. 70 cm sert aussi de voile de courtoisie

Synoptique

Panneaux écrans

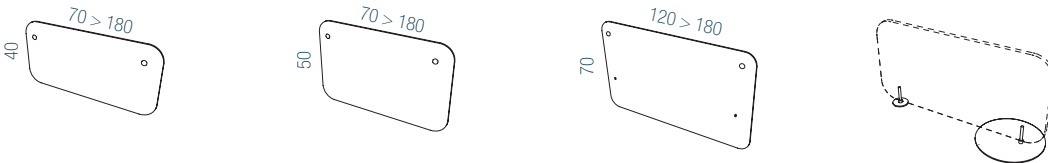

Pinces de fixation - Compatibles avec plateaux ép. 19 à 30 mm

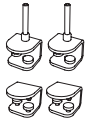

Fixation frontale postes individuels

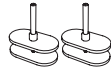

Fixation double postes vis-à-vis ou bench



Fixation traversante pour bench mono plateau

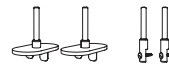

Fixation latérale en intermédiaire ou en extrémité

Rails et accessoires écrans

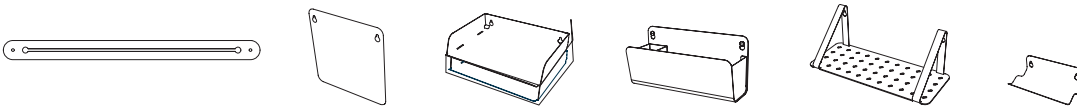

Cloisons

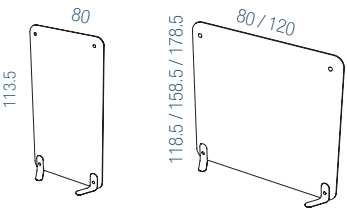

Accessoires cloisons



Tableau écritoire blanc avec plumier et pinces métal

Kit de liaison écrans et cloisons



Pieds pour cloisons : fixes (configurations cloisons seules ou multiples) ou sur roulettes

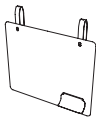

Séparer l'espace

En ligne ou en angle, fixe ou mobile, reconfigurez votre espace à volonté

Nuancier

Tissu

Écrans et cloisons ép. 47 mm



Cat. A
Bondai



Cat. B
Step Step mélange Chili



Cat. D
Fenice Cyber

Métal

Pinces, pieds, rails, accessoires

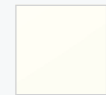

SO

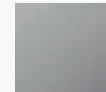

SA



SC



SG

TARIF P. 58

Détails et disponibilités

TOUTES LES RESSOURCES EN LIGNE



Rangements



Caisson métal

Page 130 ›

.....



Mélina

Page 132 ›

.....



Caisson méla éco

Page 134 ›

.....



Rehausse

Page 134 ›

.....



Léo NOUVEAU

Page 136 ›

.....



Gustave

Page 138 ›

.....



James

Page 140 ›

.....



Armand

Page 142 ›

.....



Camille

Page 146 ›

.....



Navert

Page 150 ›

.....



Ariv

Page 152 ›

.....



Armoires démontables

Page 154 ›

.....



Classeurs

Page 155 ›

.....



Rayonnages

Page 156 ›

.....



Vestiaires

Page 158 ›

.....

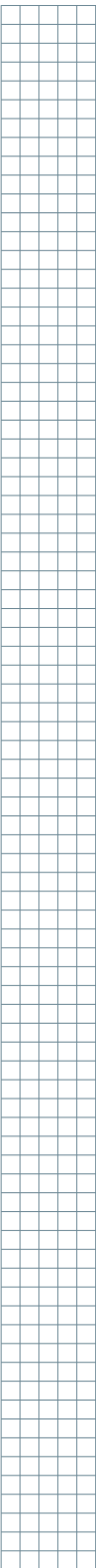



Bureaux CONECT, p. 90 -
Ecrans TWINS, p. 120

Caissons métal

UN RANGEMENT ACCESSIBLE, EFFICACE ET SÉCURISÉ

En version mobile ou à hauteur du bureau, le caisson métal optimise la surface de travail. Il apporte une touche contemporaine à l'espace grâce à ses lignes droites et épurées. Conçus en métal, ces caissons se distinguent par leur structure robuste et des finitions soignées : roulettes masquées, prise de main intégrée à la façade, top de finition.





Points forts

Compact Faible encombrement

L. 32 cm



Hauteur bureau

Caisson retour P. 60
ou extension P. 80 cm



Mobile

avec roulettes
masquées



Accessible

Façades avec
préhension latérale
Tiroir DS* à extraction
totale

*Dossiers suspendus



Organisé

Plumier intégré
Accessoires en option



Silencieux

Fermeture amortie



Sécurité

Ouverture sélective
des tiroirs, 5^{ème} roulette
anti basculement

Nuancier

Métal

Corps, tops, façades



SO

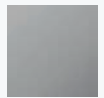

SB



SC



SG

Mélangine

Tops



MG

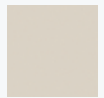

N5



R6



R9

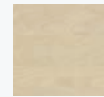

N8



RZ

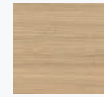

R1



R5

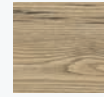

R3



N6



Zooms



Poubelle 9 L

Fixation magnétique



Lot de 3 séparateurs

Verticaux ou obliques



Coussin d'assise

Ep. 25 mm
(fixation sur top métal
par bandes aimantées)

TARIF P. 64

Détails et disponibilités

TOUTES LES RESSOURCES
EN LIGNE





Mélina

Bureaux CONECT, p. 90 - Sièges OSCAR 2, p. 228

TOUJOURS À PROXIMITÉ !

Mobile, le caisson MÉLINA se glisse sous le bureau même le plus compact grâce à sa version faible encombrement. En version retour ou extension, il optimise la surface de travail et offre un rangement accessible et sécurisé. Conçu en mélamine, MÉLINA s'harmonise avec le décor bois du plateau ou joue les contrastes de couleurs selon les envies.

Fabriqué
en France



PEFC
PEFC/07-32-197





Points forts

Compact Faible encombrement

L. 32 cm

Hauteur bureau

Caisson retour P. 60
ou extension P. 80 cm

Nuancier

Mélangé

Corps, top, façades



MG



N5



R6



R9

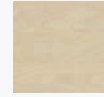

N8



RZ

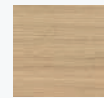

R1



R5

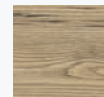

R3

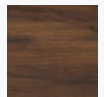

N6

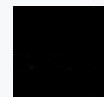

RK*

* RK : caissons mobiles
2 et 3 tiroirs uniquement

Métal

Poignée



SO

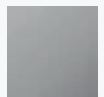

SB

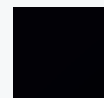

SG

TARIF P. 66

Détails et disponibilités

TOUTES LES RESSOURCES
EN LIGNE



Accessible

Tiroir pour dossiers
suspendus à extraction
totale



Mobile L. 43.2 cm

4 roulettes
dont 2 avec freins



Silencieux

Fermeture amortie



Sécurité

Ouverture sélective
des tiroirs, 5^{ème} roulette
anti-basculement



Zooms



Poignées

En métal
3 couleurs au choix



Option



Coussin d'assise

Fixation velcro
Ép. 25 mm



Bureaux Assis-debout LUTZ 2, p. 110 - Sièges OSCAR 2, p. 228

Caissons mélamine éco 71%

Ouverture sélective des tiroirs
Tiroir pour DS* anti-basculement
Plumier intégré
Selon modèle, roulettes
ø 40 mm ou vérins de réglage



Caissons mobiles

Top ép. ~19 mm
2 tiroirs dont 1 pour DS* ou 3 tiroirs
L. 43,6 x H. 59,1 x P. 56 cm

Caissons hauteur bureau

Top ép. 25 mm
3 tiroirs dont 1 DS*
L. 43,2 x H. 73,5 x P. 60 / 80 cm

*Dossiers suspendus



Rehausse 49%

Rehausse avec fond pour caissons et towers

P. 80 x L. 43,2 x H. 40 cm
Rangement immédiatement accessible



Nuancier

Mélamine

Corps, top, façades

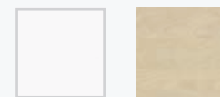

MG

N8



R1

Métal

Poignée



SB



SG

TARIF P. 67

Détails et disponibilités

TOUTES LES RESSOURCES EN LIGNE



Mélamine

Corps



MG



N5



R6



R9



N8



RZ



R1



R5



R3



N6



RK



Léo

NOUVEAU

Bureaux 4 LINE, p. 96 - Ecrans SOLANGE, p. 122 - Sièges GABIN, p. 232 -
Casiers CAMILLE, p. 146

ROBUSTESSE ET FONCTIONNALITÉ

Découvrez notre Tower en métal, conçu pour allier robustesse et durabilité. Idéal pour les espaces de travail professionnels, ce caisson de rangement vertical optimise l'espace tout en offrant un stockage important et facilement accessible.





Points forts



Stable

5ème roulette antibasculement



Réversible

Au choix : ouverture à droite ou à gauche



Fermeture sécurisée

Serrure à clé



Synoptique

Tower bas	Tower haut	Option
-----------	------------	--------

Tower - Sans top

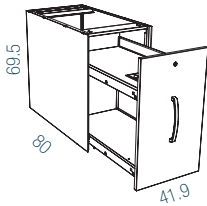

Tower - Avec top

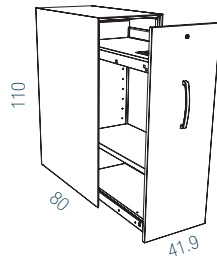

Top pour caisson bas



Nuancier

Métal

Corps, tops, façades



SO



SB



SC



SG

Mélamine

Top pour tower bas ép. 25 mm

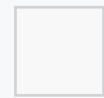

MG

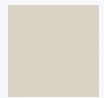

N5



R6



R9

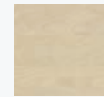

N8



RZ

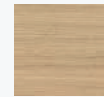

R1



R5

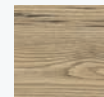

R3

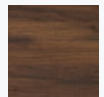

N6

TARIF P. 68

Détails et disponibilités

TOUTES LES RESSOURCES EN LIGNE





Gustave

Bureaux ARIAL, p. 86 - Sièges LEON, p. 230 -
Rehausses p. 135

ASTUCIEUX & FONCTIONNEL !

Organisez votre espace de travail avec notre tower GUSTAVE. Grâce à ses multiples étagères de rangement, il optimise l'espace tout en s'intégrant parfaitement dans un environnement professionnel moderne. Une solution pratique et design pour un bureau toujours ordonné.

Accessoires

Accessoires à monter sur rail optionnel



^
Vide poche/
Jardinière



^
Plumier



^
Étagère



^
Tableau magnétique

Fabriqué
en France





Points forts



Silencieux

Fermeture amortie



Préhension optimale

Grande poignée en aluminium



Réversible

Au choix : ouverture à droite ou à gauche



Kit d'électrification

(Option)



Synoptique

Towers individuels

Tower bas

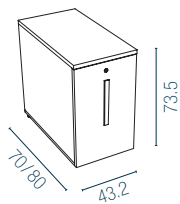

Tower haut

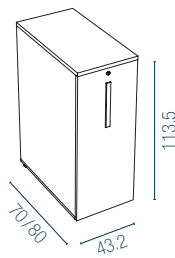

Tower partagé

Ouverture double accès avec espace sécurisé de chaque côté

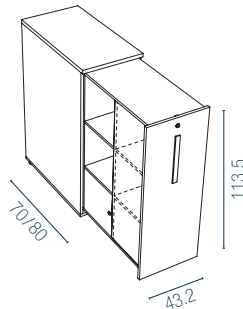

Nuancier

Mélamine

Corps, tops, façades



MG



N5



R6



R9

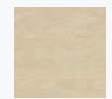

N8



RZ

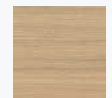

R1



R5



R3

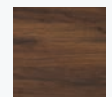

N6

TARIF P. 69

Détails et disponibilités

TOUTES LES RESSOURCES
EN LIGNE





James

Bureaux CONECT, p. 90 -
Cloisons & Ecrans SOLANGE, p. 122 -
Sièges ELIOTT, p. 234 -
Lampadaire NEO, p. 272 -
Lampe OL02, p. 272

 **2 pieds de soutien**



Pied incliné
Hêtre massif (ROBIN)



Pied droit
Métal (CONNECT et ARIAL)

 **Option**



Support courrier
A suspendre au dos de la porte du casier

Fabriqué
en France



PEFC
PEFC/07-32-197



Points forts



Accès immédiat

Cubes ouverts en métal ou filaire)

Accès sécurisé

Bloc 2 cases fermées à clé pour ranger ses effets personnels

Espace courrier

Porte avec fente pour support courrier



Synoptique

Pour bench P. 165 cm*

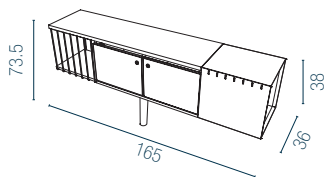
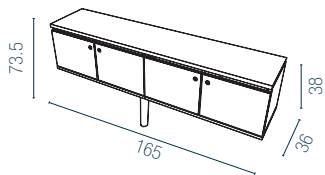

Pour bench P. 142 cm

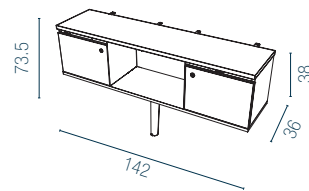

Options



Séparateur métal 4 cases (uniquement pour Bench P.142 cm)



Support courrier

* Compatibles pour Bench ARIAL, CONECT et ROBIN

Nuancier

Mélamine

Corps, top, façade



MG



N5

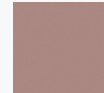

R8



R7



R6



R9

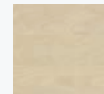

N8



RZ

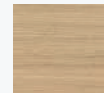

R1



R5

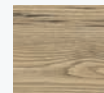

R3

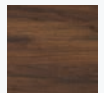

N6

Métal

Cubes, pied de soutien (ARIAL, CONECT), options

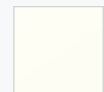

SO



SA



SC



SG

Métal / Bois massif

Pied de soutien (ROBIN)



SOMS



SGMS

TARIF P. 70

Détails et disponibilités

TOUTES LES RESSOURCES EN LIGNE





Armand

DES RANGEMENTS ADAPTÉS À TOUS LES BESOINS

Avec ses finitions bois et sa multitude de possibilités, ARMAND structure et aménage les espaces de travail en y apportant une touche habitat.

Fabriqué
en France



PEFC
PEFC/07-32-197





Bureaux Assis-debout AXEL 2, p. 114 - Sièges OPUS, p. 233 - Lampes AVA, p. 272

Disponible en version armoire, bibliothèque ou penderie, avec portes battantes ou coulissantes, ARMAND offre une solution adaptée à chaque besoin de rangement.



Points forts



Choix des ouvertures

Avec ou sans porte
Coulissante ou battante



Silencieux

Fermeture amortie
grâce aux charnières
auto-freinées



Nouvelle H. 100

Respecte la hauteur
d'allège



Sécurisé

Porte mélamine
avec serrure à clé



Réglage des vérins

par l'intérieur
du meuble



Zooms



Rail

Pour portes coulissantes



Poignées métal

Pour portes battantes
3 couleurs au choix



Poignées métal

À préhension latérale
pour portes coulissantes
3 couleurs au choix

Synoptique

Armoires portes battantes

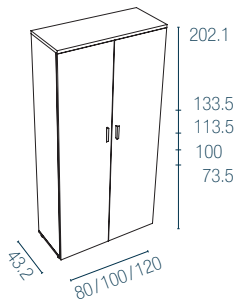

2 portes mélamine

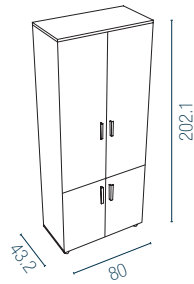

4 portes mélamine

Armoires portes coulissantes

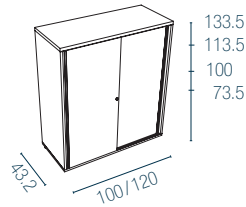

2 portes mélamine

Bibliothèques

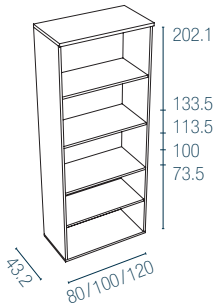

Ouverte

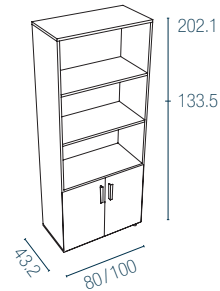

2 portes mélamine

Penderie**

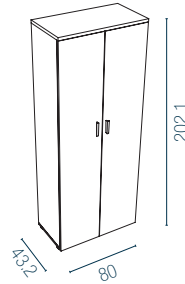

2 portes mélamine
(2/3 penderie 1/3 tablettes)

Meuble séparateur**

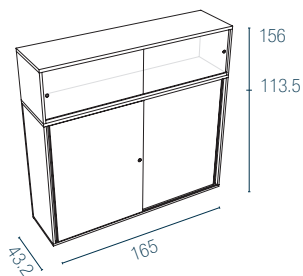

2 portes coulissantes mélamine
Réhausse 2 portes Altuglas®

Meuble bas**

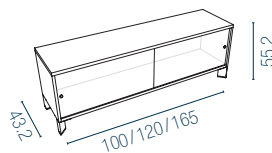

2 portes coulissantes Altuglas®

En option : dessus de finition, tablettes mélamine ou métallique
** Non disponible en coloris RK

Nuancier

Mélamine

Corps, top, façades



MG



N5



R7*



RK



R6

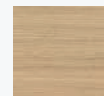

R1

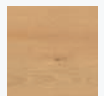

R5

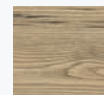

R3

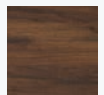

N6



R9

* R7 Portes uniquement

Métal

Poignées

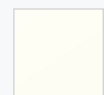

SO

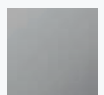

SB



SG

Altuglas®

Portes rehausse
et meuble bas

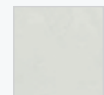

SO

TARIF P. 71

Détails et disponibilités

TOUTES LES RESSOURCES
EN LIGNE





Camille

RANGEMENT PERSONNEL POUR POPULATION NOMADE

CAMILLE simplifie l'arrivée des visiteurs et collaborateurs dans l'entreprise en leur offrant un espace de rangement individuel et sécurisé.

Fabriqué
en France



PEFC
PEFC/07-32-197





Bureaux Assis-debout AXEL 2, p. 114 - Sièges OPUS, p.233 - Lampes AVA, p. 272

Disponibles en version porte simple ou double, avec ou sans fente courrier, les casiers CAMILLE permettent de ranger casques moto ou vélo, valise cabine en plus des effets personnels. Au choix, serrure à clé ou à code, porte mélamine ou métal.



Points forts



Choix des matières

Portes métal ou mélamine



Choix des portes

Simple adaptée à un casque moto
Double adaptée au format valise
cabine



Silencieux

Fermeture amortie



Ventilé

Dos perforé



2 types de serrures



Serrure à clé

Pour portes mélamine

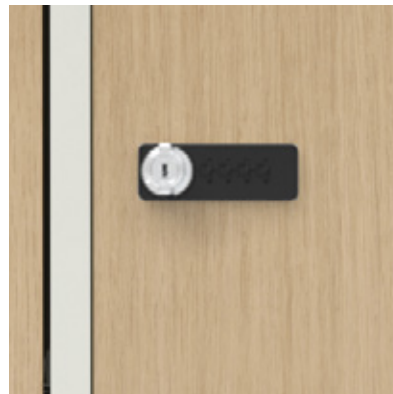

Serrure à code

Pour portes métal
ou mélamine

Synoptique

Corps (livrés montés)

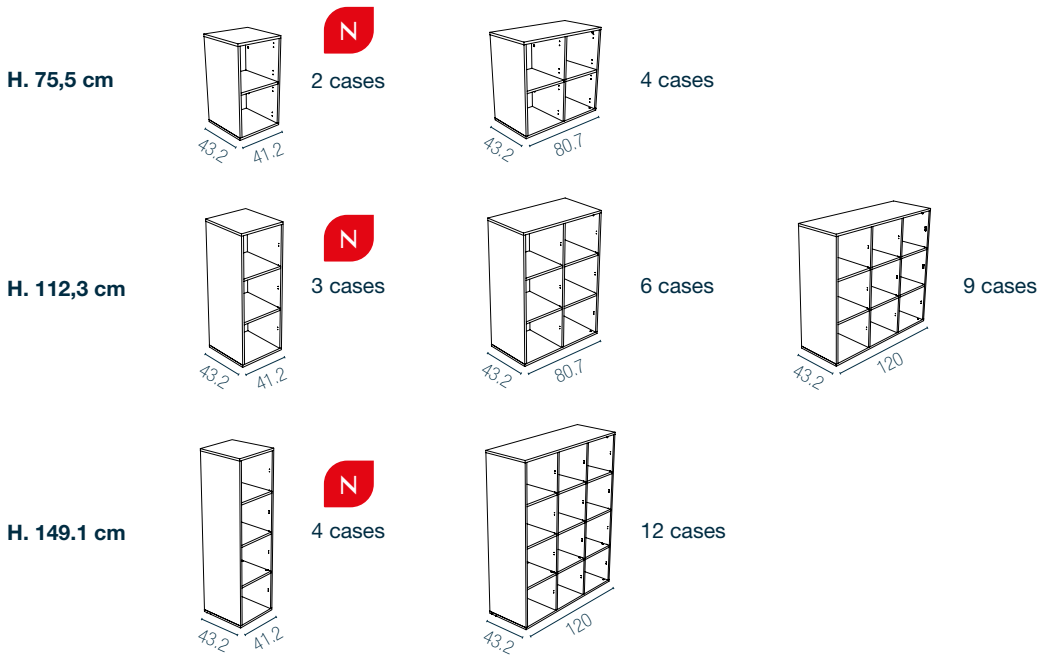

Portes (avec ou sans fente courrier)

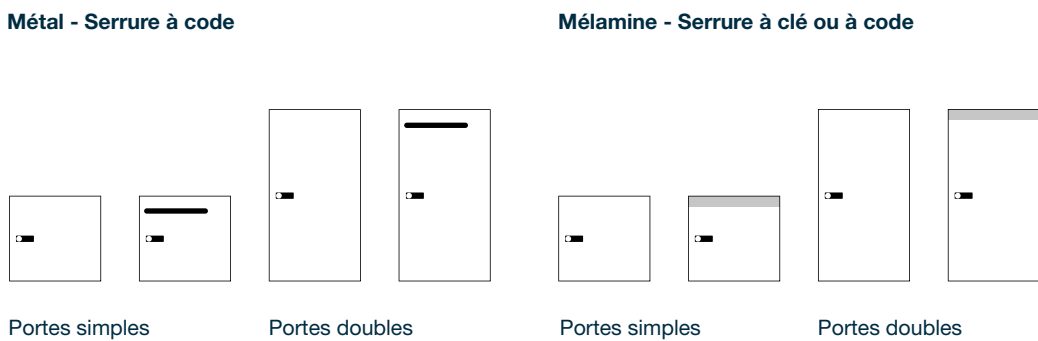

Porte simple pour 1 case. Dim. utiles : L. 37,4 x H. 34,9 x P. 39 cm
 Porte double pour 2 cases. Dim. utiles : L. 37,4 x H. 71,5 x P. 39 cm (En option : tablette complémentaire)

Options



4 pieds carrés ABS
H. 5 cm



Socle métal
H. 20 cm



Support courrier avec porte étiquette
À suspendre au dos de la porte mélamine



Porte-carte
À positionner sur la fente de la porte

Nuancier

Mélangine

Corps, portes

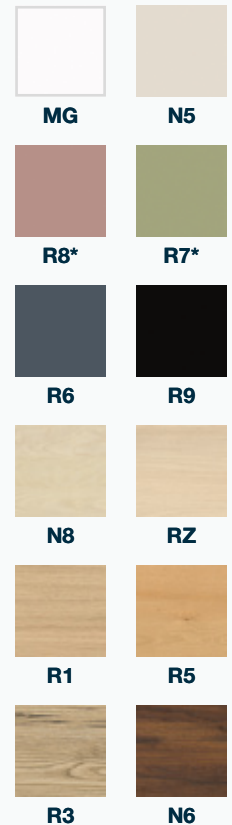

* R7/R8 :
Portes uniquement

Métal

Portes, socle, support courrier

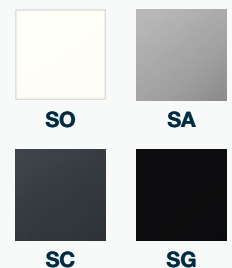

TARIF P. 74

Détails et disponibilités

TOUTES LES RESSOURCES EN LIGNE



Navert



Non feu

Rideaux PVC M1



Harmonie des finitions

Lame terminale assortie à la couleur du coffre

Tablettes blanches pour coffre blanc

Tablettes noires pour les autres finitions



Fond plat

Pour une extraction facilitée des dossiers en bas de l'armoire



Jusqu'à 5 niveaux de classement

Une tablette encastrée en partie haute permet d'accueillir les dossiers suspendus



Zooms



Réglage des vérins par l'intérieur



Ouverture facilitée

Poignées rectangulaires encastrées

Fabriqué
en France

OFFICE
EXCELLENCE
CERTIFIÉ NF

TÜV
GS

GARANTIE
5 ans

49
%



Accessoires



Classer

- Classement à plat ou pour dossiers suspendus (tablettes métalliques avec système de rail)
- Classement vertical optimisé grâce à des séparateurs verticaux H.18 cm
- Accès facilité aux dossiers suspendus grâce à l'option châssis télescopique (avec système d'ouverture sélective)

Consulter

Tablette de consultation télescopique à extraction totale

Installer rapidement

Repères de positionnement des tablettes et châssis télescopiques (pas de 25 mm)

Nuancier

Métal

Corps



SO



SD

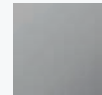

SB



SC



SG

PVC

Rideaux

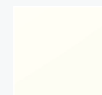

SO

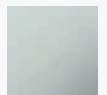

SD

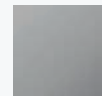

SB



SC



SG

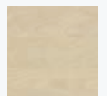

N8

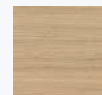

R1



R5

Top mélaminé ép. 25 mm assorti au bureaux

Au choix armoire unicolore ou bicolore (cf. tarif)

TARIF P. 75

Détails et disponibilités

TOUTES LES RESSOURCES EN LIGNE



Synoptique

Armoires hautes

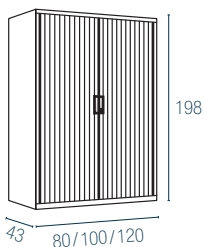

Armoires intermédiaires

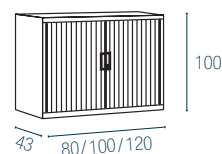
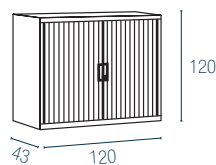
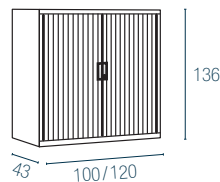

Armoires hauteur plan de travail

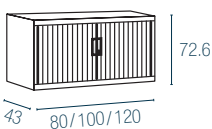

Ariv



Non feu

Rideaux PVC M1



Harmonie des finitions

Lame terminale et tablettes assorties à la couleur du coffre



Zooms



Réglage des vérins par l'intérieur



Visibilité et accès immédiat aux dossiers

Ouverture totale des rideaux



Jusqu'à 5 niveaux de classement

Un rail en partie haute permet d'accueillir les dossiers suspendus (sauf H.72,1 cm et rehausse)



Fermeture aimantée



Ouverture facilitée

Poignées rectangulaires encastrées





Accessoires



Classer

- Classement à plat ou pour dossiers suspendus (tablette métallique avec système de rail)
- Classement vertical optimisé grâce à des séparateurs verticaux H. 19 cm
- Trieur 16 cases format A4 L. 104 x P. 33 x H. 32 cm (à poser sur une tablette L. 120 cm)
- Accès facilité aux dossiers suspendus grâce à l'option châssis télescopique (avec système d'ouverture sélective)
- Possibilité de consulter les dossiers suspendus de face grâce à des traverses et arceaux anti débordements (Incompatible avec armoire L. 80 x H. 72,1 cm)

Consulter

Tablette de consultation télescopique à extraction totale

Installer rapidement

Repères de positionnement des tablettes et châssis télescopiques (pas de 20mm)

Nuancier

Métal

Corps

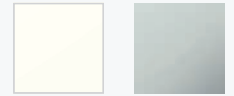

SO

SD



SB

SC



SG

PVC

Rideaux



SO

SD



SB

SC



SG

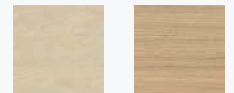

N8

R1

Au choix, armoire unicolore ou bicolore cf. tarif
Top mélaminé ép. 25 mm assorti au bureaux

TARIF P. 76

Détails et disponibilités

TOUTES LES RESSOURCES EN LIGNE



Synoptique

Armoires hautes

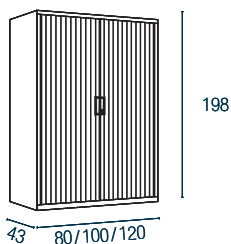

Armoires intermédiaires

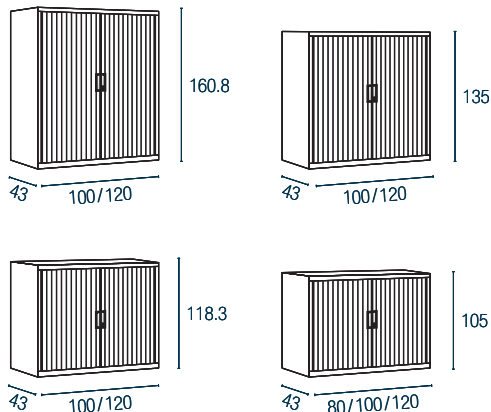

Armoires hauteur plan de travail

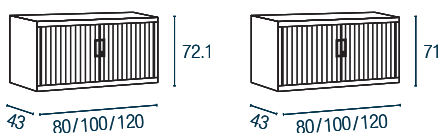

Réhausse

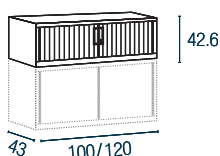

Armoires démontables



Non feu

Rideaux PVC M1



Fermeture aimantée & sécurisée

Lame terminale, serrure 2 points



Classement à plat ou pour dossiers suspendus



Jusqu'à 5 niveaux de classement

Un rail en partie haute permet d'accueillir les dossiers suspendus



Synoptique

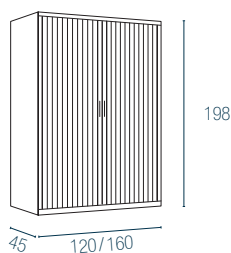

Nuancier

Métal & PVC



SDDS
Gris clair



SDSC
Gris anthracite

TARIF P. 77

Détails et disponibilités

TOUTES LES RESSOURCES
EN LIGNE



Classeurs dossiers suspendus



.....
Serrure centralisée
 (clé passe sur demande)

.....
Ouverture sélective
 des tiroirs et système de sécurité anti-basculement

.....
Poignées ergonomiques
 et porte-étiquettes intégrés

.....
Glissières télescopiques
 à billes avec aspiration en fin de course

.....
Tiroirs pour dossiers suspendus
 format A4

.....
En option :
 fond cranté pouvant recevoir des intercalaires

.....
3 hauteurs : 71,1 / 101,6 / 132,4 cm
 (L. 41,3 x P. 62,2)

Nuancier

Métal

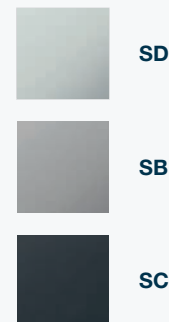

TARIF P. 77

Détails et disponibilités

TOUTES LES RESSOURCES EN LIGNE



Classeurs à tiroirs



.....
Poignées PVC
avec porte-étiquettes intégrés
 (étiquettes non fournies)

.....
Serrure
 tous les 2 tiroirs

.....
Glissières à billes
 extraction 80 %

.....
Tiroirs pour dossiers suspendus
 format A4

.....
2 hauteurs : 67,2 / 128,2 cm
 (L. 41,3 x P. 40)

Nuancier

Métal

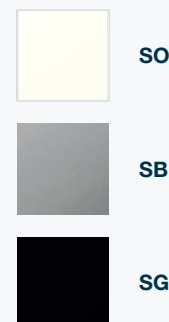

TARIF P. 77

Détails et disponibilités

TOUTES LES RESSOURCES EN LIGNE



Rayonnages tubulaires



^
Montage rapide et sans outils
 Par simple emboîtement

^
Montants profilés en «T»
 Acier ép. 7/10^{ème}

^
Tablette composée de 3 ou 4 traverses
 En acier galvanisé
 200 kg max. par traverse

^
Dessus Isorel
 (Option)

□ Synoptique

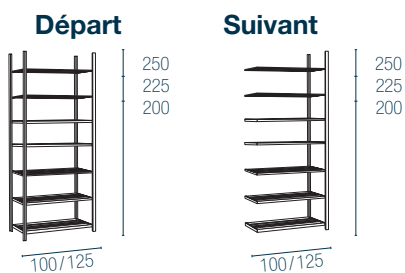

P : 35/50/70

Nuancier

Métal
 Montants peints



SC

Métal
 Montants galvanisés



ZJ

TARIF P. 78

Détails et disponibilités

TOUTES LES RESSOURCES
 EN LIGNE



Fabriqué en France



Rayonnages polyvalents



Stable

Fond croisillonné

Montants 35 x 35 mm

Tablettes métalliques pleines

120 kg max

Par tablette

Classement à plat
ou pour dossiers suspendus

Tablette métallique avec système de rail

Synoptique

Départ

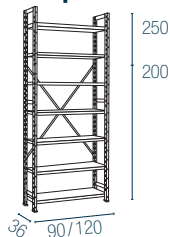

Suivant

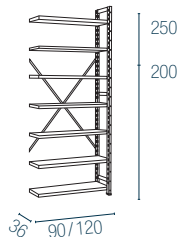

Nuancier

Métal
Peint



SDSC

Métal
Galvanisé



ZJZJ

TARIF P. 79

Détails et disponibilités

TOUTES LES RESSOURCES
EN LIGNE



Fabriqué
en France



Nuancier

Métal

Corps et portes



SDSD
Gris / Gris



SDSK
Gris / Bleu

TARIF P. 80

Détails et disponibilités

**TOUTES LES RESSOURCES
EN LIGNE**



Vestiaires industriels



Industrie propre

Industrie salissante



**Vestiaires monoblocs
et démontables**

**Equipés d'une tablette
avec tringle porte-cintres**

Porte-étiquette embouti
(étiquette non fournie)

Ventilations

en partie haute, basse et à l'arrière

Fermeture par morillon

porte-cadenas (cadenas non fourni)

Séparation médiane

pour protéger les vêtements
de ville (vestiaires industrie
salissante uniquement)

Nuancier

Métal

Corps et portes



SDSK
Gris / Bleu



SDX1
Gris /
Anthracite

TARIF P. 80

Détails et disponibilités

**TOUTES LES RESSOURCES
EN LIGNE**



Vestiaires multicases



Vestiaires démontables

Tringle et porte-cintres

Aération

En partie haute et à l'arrière

Tablettes anti-effraction

Entre 2 cases superposées

**Fermeture par morillon
porte-cadenas**

(cadenas non fourni)



Options



Toits en pente

H. 13 x P. 50 cm

Existe en largeur 60, 80, 90 ou 120 cm

Pour vestiaires monoblocs et démontables



Socles pieds

H. 15 x P. 50 cm

Existe en largeur 60, 80, 90 ou 120 cm

Pour vestiaires démontables



Socles bancs

H. 25 x P. 80 cm

Existe en largeur 60, 80, 90 ou 120 cm

Pour vestiaires monoblocs et démontables



Jeu de 4 pieds

H. 15 cm

Pour vestiaires monoblocs

Bancs indépendants



Existe en 3 longueurs

L. 120, 160 et 200 cm



Piètement métal

Tube carré finition gris clair
Avec vérins de réglage



Assise en bois massif

3 lattes en hêtre clair verni



PEFC
PEFC/07-32-197



Espaces réunion & collectivités



Espaces réunion & collectivités



Arial

Page 164 ›

.....



Robin

Page 170 ›

.....



Karl

Page 172 ›

.....



Modulo NOUVEAU

Page 178 ›

.....



Alma NOUVEAU

Page 182 ›

.....



Nomad NOUVEAU

Page 186 ›

.....



Martin

Page 192 ›

.....



Ping

Page 196 ›

.....



Chatbox

Page 198 ›

.....



Emi

Page 202 ›

.....



Tables pliantes

Page 203 ›

.....



Tables polyvalentes

Page 204 ›

.....



Tables abattantes

Page 206 ›

.....



Éloïse NOUVEAU

Page 210 ›

.....



Élisa NOUVEAU

Page 214 ›

.....



Évasion

Page 216 ›

.....



Lucie

Page 218 ›

.....



Gaby NOUVEAU

Page 220 ›

.....

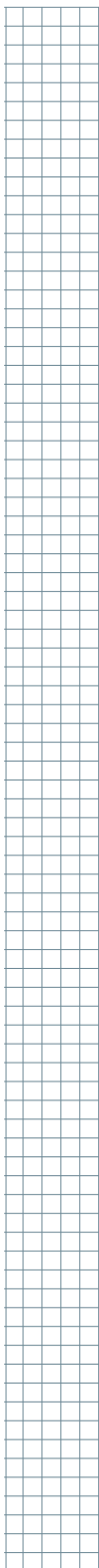



Arial

RENDRE L'ESPACE AGILE

Pour les espaces de formation ou de réunion, fixe ou mobile, en version haute ou standard, ARIAL réunion offre de multiples solutions d'aménagement.

Fabriqué
en France



PEFC
PEFC/07-32-197





Tabouret GELATI, p. 258 - Sièges OSCAR 2, p. 228 - Assises et tables basses ZELIE, p. 22/46 -
Tableau mobile MARTIN, p. 192 - Cloisons et écrans SOLANGE, p. 122 - Lampe AVA, p. 272

Sa version mobile apporte de l'agilité aux environnements de travail. Elle permet aux collaborateurs de reconfigurer l'espace selon leurs usages sans changer de pièce.



Points forts



Différentes hauteurs

H. 73.5
ou tables H. 104.5 cm.
(Existe aussi en H. 90 cm
pour les tables P. 80 cm)



Choix des configurations

Forme carrée ou rectangulaire
Tables faible profondeur
ou tables grande capacité



Électrification variée

Obturbateurs avec connexion
directe ou trappe centrale
double accès



Ergonomie & stabilité

Tables hautes avec repose-pieds
pour un confort optimal
Câbles de tension pour
plus de stabilité



Différents types de piétements



Arche fixe

H. 73.5, 90 ou 104.5 cm



Arche mobile

H. 73.5 ou 104.5 cm



Zoom

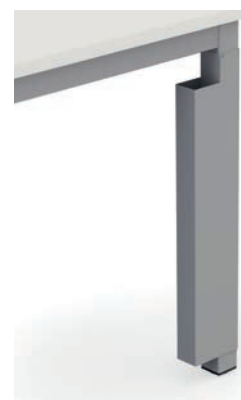

Carter aimanté à clipser

Permet la descente des câbles



Chaises LOUIS, p. 244 - Cabines CHATBOX, p. 198 - Casiers CAMILLE, p. 146 - Lampes AVA, p. 272

Exemples de configurations



Travailler

Se poser un moment pour lire un rapport ou corriger un document



Se détendre

2 hauteurs possibles pour la table P. 80 cm :
H. 90 ou 104.5 cm



Sièges LEON, p. 230 - Cloisons SOLANGE, p. 122

Exemples de configurations

Une journée avec Arial mobile !



Se concentrer

L'équipe s'installe pour travailler individuellement. Les cloisons SOLANGE séparent visuellement les collaborateurs, chacun peut se concentrer.



Se réunir

Grâce aux tables mobiles, l'équipe transforme l'espace pour se réunir, brainstormer et échanger. Le tableau mobile MARTIN, permet de rester connecté avec les collaborateurs qui travaillent en distanciel.

Synoptique

Tables rectangulaires

H. 73.5 et H. 104.5 cm

H. 90 cm (uniquement Tables P. 80 cm) 

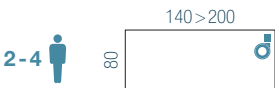

 Existe en version mobile

Tables grande capacité

H. 73.5 et H. 104.5 cm

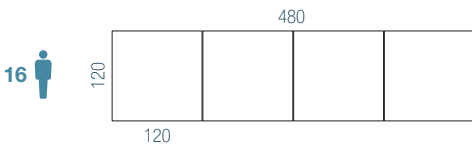
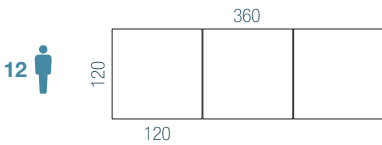
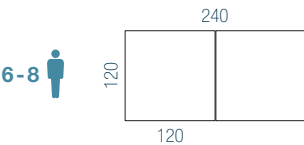

Tables carrées

H. 73.5 et H. 104.5 cm

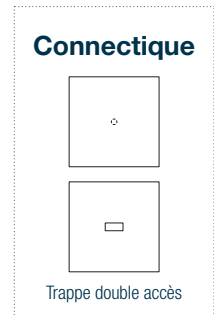
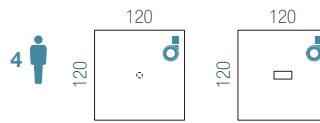

Nuancier

Mélanges

Plateaux ép. 25 mm

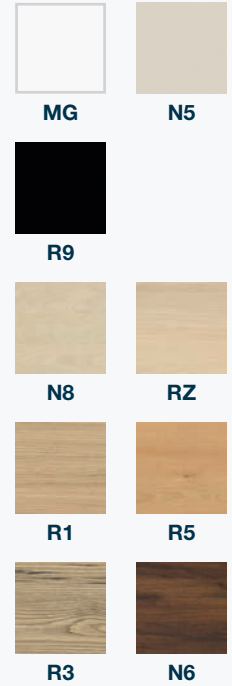

Métal

Piétements

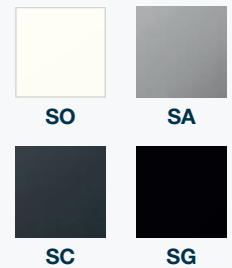

 Plus de choix disponibles

TARIF P. 84

Détails et disponibilités

TOUTES LES RESSOURCES EN LIGNE



 ARIAL existe aussi en version Bureaux p.786



Robin

Chaises SCOTT, p. 250 - Rangements GRETA, p. 50

DES LIGNES DOUCES ET MODERNES

Inspiré des codes de l'habitat, Robin se distingue par l'élégance de ses pieds en hêtre massif. Légèrement arrondis, ils apportent douceur et chaleur aux environnements de travail avec une touche de modernité. Disponible en différents formats, ROBIN est le partenaire idéal pour aménager vos espaces réunion.

Fabriqué
en France

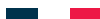

PEFC
PEFC/07-32-197





Points forts



Variété des usages

Différents formats et dimensions, 2 hauteurs, petites tables ou tables grande capacité



Confortable & esthétique

Repose-pieds design avec barres de tension pour une stabilité optimale



Électrification variée

Obturbateurs avec connexion directe ou trappe centrale double accès



Synoptique

2 hauteurs : H. 73.5 et H. 104.5 cm

Tables carrées

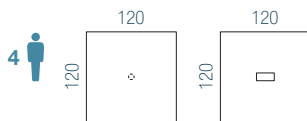
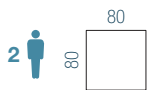

Tables rectangulaires

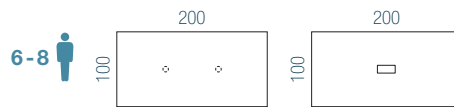
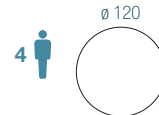
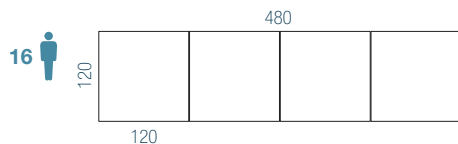
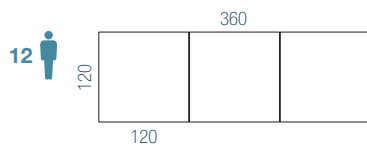
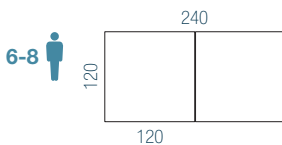

Table ronde



Tables grande capacité



Connectique



Trappe double accès



ROBIN existe aussi en version Bureaux p.100 et p. 76

Nuancier

Mélangé

Plateaux ép. 25 mm



MG

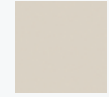

N5



R9

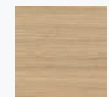

R1

Métal

Platine pieds, repose-pieds



SO

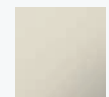

ZC



SG

Bois massif

Pieds



MS

TARIF P. 87

Détails et disponibilités

TOUTES LES RESSOURCES EN LIGNE





Karl

ÉLÉGANCE ET CARACTÈRE DES ESPACES DÉCISIONNELS

KARL se distingue par l'élégance de son dessin et la noblesse de ses matériaux. Son pied en chêne massif associé aux différents coloris de plateaux impose un style singulier aux espaces Premium

Fabriqué
en France





Chaises LOUIS, p. 244 - Lampe CHAMPI, p. 272

Disponible en différents formats de tables avec trappe double accès intégrée sur le plateau, KARL équipe les petits et les grands espaces de réunion jusqu'à des salles de conférence de 20 personnes.



Points forts



Des tables pour petits ou grands espaces

Carrées ou rectangulaires de 6 à 20 personnes



Électrification discrète

Passage de câbles intégré au piétement



Goulotte structurelle incluse

Permet l'acheminement des câbles sous le plateau jusque dans les pieds



Zooms



Élégance des espaces

Des formes douces (plateaux coins arrondis) alliées à des matières nobles (pieds en chêne massif)



Chaise SCOTT, p. 250 - Lampes CHAMPI, p. 272

Zooms



^ Pied électrifié

Accès aux câbles par un cache en bois à visser (version plateau avec trappe)



^ Trappe soft closing double accès

Intégrée et assortie à la couleur du plateau (excepté pour le bois Noir RK, trappe coloris noir)





Chaises SCOTT, p. 250

**Exemples
de configurations**



Le style par l'assise

Avec les chaises ISABEL,
pour un style élégant et intemporel



Avec les chaises SCOTT pour un effet
très contemporain

Synoptique

Tables carrées

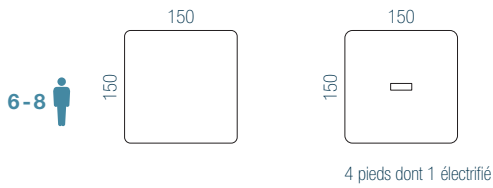

Tables rectangulaires

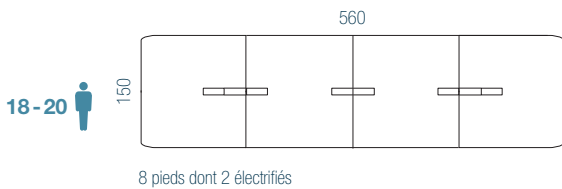
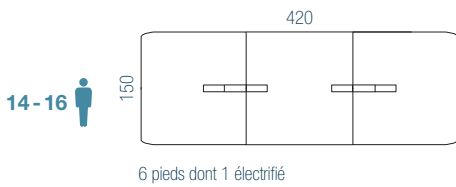
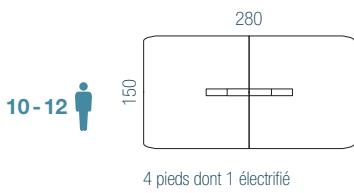

KARL existe aussi en version Bureaux de direction p.80



Diriger/ Se réunir

Une table carrée pour compléter un bureau ou équiper un petit espace



Une table rectangulaire pour se réunir en équipe dans un style Premium

Nuancier

Mélamine
Plateaux ép. 25 mm

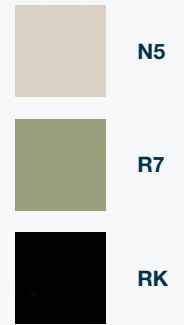

Métal
Structure

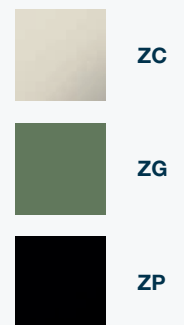

Bois massif
Piétements



TARIF P. 89
↓
Détails et disponibilités

TOUTES LES RESSOURCES EN LIGNE
↓





Modulo

NOUVEAU

Assises BIP, p. 42

LA RÉUNION MODULAIRE ET CONNECTÉE

MODULO est la gamme idéale pour aménager vos salles de conférence et grands espaces de réunion. Elle offre de multiples configurations de tables ouvertes ou fermées. Grâce à ses kits extension, les tables peuvent être dimensionnées pour s'adapter à vos besoins.

Fabriqué
en France





Points forts



Variété des configurations

Tables ovales, elliptiques, rondes, en U, V et losange.

De 10 à 20 personnes ou plus grâce aux kits extension



Personnalisable

Choix des pieds : panneaux ou métal

Possibilité d'ajouter un voile de fond assorti



Choix de l'électrification

Plateaux pré-perçés obturateurs pour connexion directe ou découpés pour trappe



3 types de piétements



Pied panneaux

(Mélamine ép. 30 mm)



Pied métal rond

(Section \varnothing 70 mm)



Pieds métal triangulaires

(Avec et sans descente de câbles intégrée)



Chaises LOUIS, p. 244

Zooms



Électrification optimisée et variée

^
Plateaux pré-perçés obturateurs optionnels avec connexion directe (1PC ou 1PC + USB A & C)



^
Plateaux découpés pour trappe simple accès nue ou électrifiée (goulottes et guides câbles intégrés)



^
Guide câbles entre 2 goulottes (compatible pieds panneaux et métal)

Synoptique

Tables

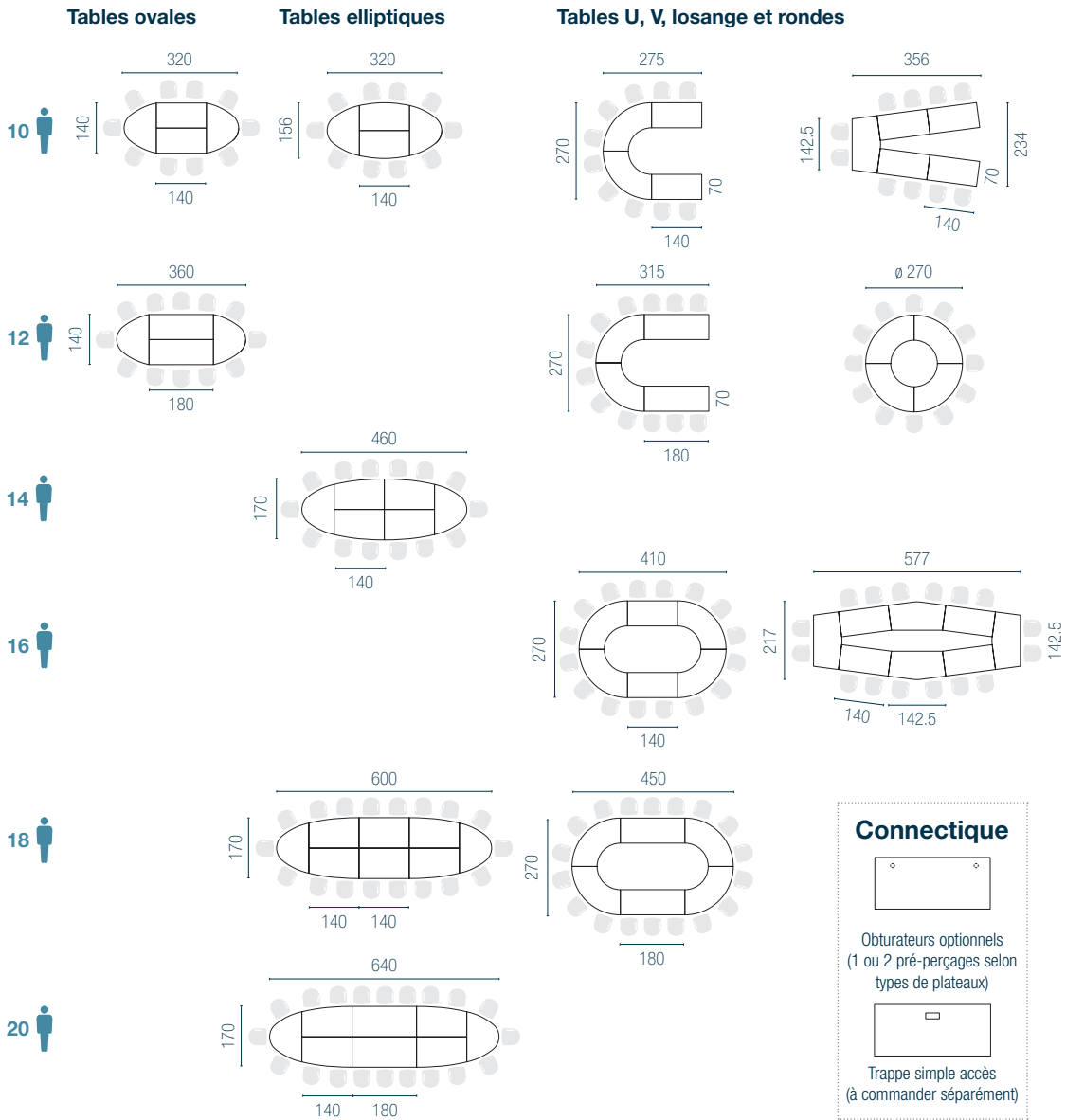

Kits extension

Pour tables ovales

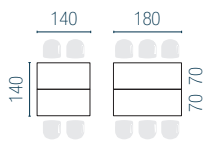

L.140 ou L180 cm
Pour 4 ou 6 personnes

Pour tables elliptiques

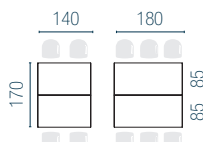

L.140 ou L180 cm
Pour 4 ou 6 personnes

Pour tables U, V, losange et rondes

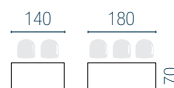

L.140 ou L180 cm
Pour 2 ou 3 personnes

Options

Goulottes métal

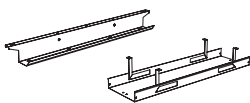

Simple

Double

Guide câbles métal



Pour pieds panneaux et métal

Voiles de fond métal et mélamine H. 28 cm

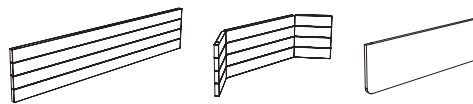

Métal

Métal pour angle 90°

Mélamine

Vous souhaitez une configuration spécifique ? Consultez votre responsable commercial

Nuancier

Mélamine

Plateaux & piétements ép. 30 mm

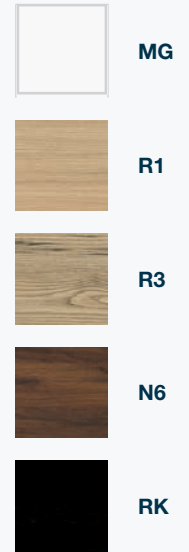

Métal

Piétements

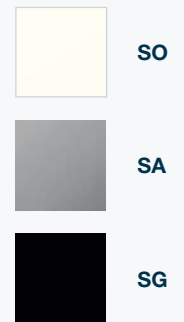

TARIF P. 90

Détails et disponibilités

TOUTES LES RESSOURCES EN LIGNE





Alma

NOUVEAU

LA TABLE CONNECTÉE

Répondant aux nouveaux modes de travail, ALMA offre des solutions complètes pour réaliser vos présentations ou vos visioconférences. Disponible en version hauteur standard ou table haute, elle permet grâce à sa réhausse de recevoir un écran afin de diffuser vos présentations et rester connecté avec vos collaborateurs..

Fabriqué
en France





Tabourets SOFIA, p. 264 - Bureaux CONECT, p. 90 - Ecrans SOLANGE, p. 122 - Sièges GABIN, p. 232

La table ALMA offre également une connexion discrète et facile via une gestion horizontale et verticale des câbles. Une solution clé en main adaptée au mode de travail hybride pour des espaces aussi ordonnés que connectés.



Chaises SCOTT, p. 250

Zooms



Gestion horizontale des câbles

Capot pivotant en bout de table permettant d'accéder à une goulotte



Gestion verticale des câbles

Goulotte pour recevoir des boîtiers prises et descendre les câbles via une gaine zippée incluse



Support écran inclus

Support écran pour écran de 23 à 42 pouces, maxi 40 kg et Vesa maxi 200x200
Cache amovible inclus.



Points forts



Des lignes graphiques et épurées

Une structure en métal section carrée 30x30 mm.
1 seule dimension de plateau
L. 100 x P. 180 cm

Des configurations variées

Existe en 2 hauteurs avec ou sans réhausse pour support écran

Electrification complète & optimisée

Gestion horizontale et verticale des câbles



Synoptique

Tables H. 74 cm

Avec ou sans rehausse pour support écran*

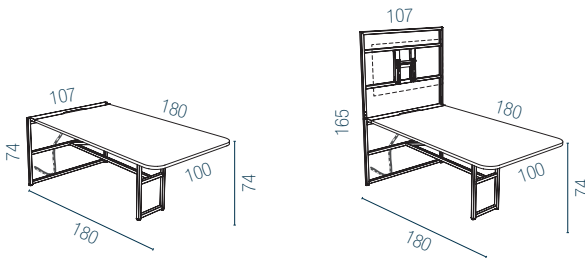

Tables H. 105 cm

Avec ou sans rehausse pour support écran*

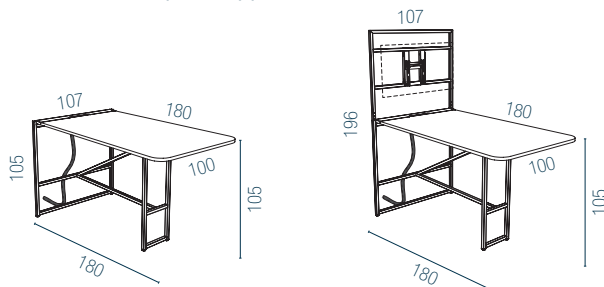

* Support écran inclus (TV non incluse)
Goulotte et gaine zippée incluses

Nuancier

Mélamine

Plateaux ép. 25 mm



MG



N5



R9

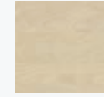

N8



RZ

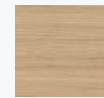

R1



R5

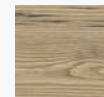

R3

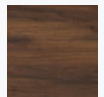

N6

Métal

Structure et capot pivotant

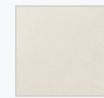

ZO



ZP

TARIF P. 99

Détails et disponibilités

TOUTES LES RESSOURCES
EN LIGNE





Nomad

NOUVEAU

LA TABLE DYNAMIQUE & PERSONNALISABLE

La table NOMAD s'adapte aux besoins des utilisateurs à tout moment de la journée. Cette table est équipée d'un ingénieux système afin d'ajuster la hauteur du plateau : standard ou haute. Les utilisateurs peuvent ainsi passer d'une position assise à debout en un clin d'œil.

Fabriqué
en France





Poufs ZELIE p. 22 - Tables PING, p. 196 - Chaises & tabourets SOFIA, p. 264 - Assises ANOUK, p. 28 - Armoires ARMAND, p. 142

En version fixe ou mobile, cette table de réunion, de détente ou de travail, crée des lieux d'échanges tout en favorisant la créativité et la convivialité. Personnalisable et complète, elle offre une variété d'accessoires pour répondre aux différents besoins et usages.



Points forts



Multi-usages

Table projet ou de détente pour des réunions informelles ou en coworking

Existe en version fixe ou mobile

Possibilité de tables départ/suivant (fixe uniquement)



Alterner les postures

Table ajustable manuellement en 2 positions :

Assis (H. 73.5 cm)

ou Debout (H. 104.5 cm)

Manipulation facile et rapide du plateau par une seule personne



Personnalisable

Nombreux accessoires pour équiper votre table



Piètements

Structure en A (section 60x30 mm)



Zooms



Repose-pieds

Double barre pour un confort immédiat



Multi-fonctionnel

Enrouleur de fil pour ranger et guider le câble. Il peut aussi accueillir un sac.



Ajustable

Un mécanisme sous plateau associé à des rails de guidage insérés dans les piètements permettent d'accompagner le mouvement du plateau.



Sièges OSCAR 2, p. 228 - Tableau mobile MARTIN, p. 192 - Poufs ZELIE p. 22

Zooms



^ Mobile

4 roulettes noires avec frein
 ø 75 mm, tous types de sols
 Vérins de mises à niveau
 pour la version fixe



^ Lignes légères et arrondies

Plateaux ép. 19 mm, coins arrondis



Chaises SCOTT, p. 250

⌈
⌋
↗
Exemples
□
⌈
⌋
de configurations



^
Se réunir

Un lieu d'échange et de partage pour des réunions dynamiques et collaboratives



^
Se détendre

Idéale pour créer des ambiances conviviales et chaleureuses au sein des espaces de travail

Synoptique

Tables assis / debout

Plateau nu L.180 x P. 90 cm

2-6  **Table mobile**

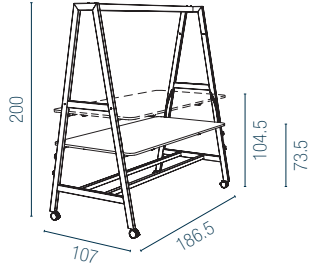

2-6  **Tables fixes**

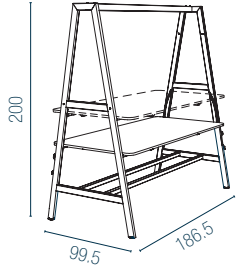

Départ

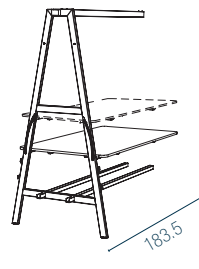

Suivant (pied intermédiaire)

Accessoires

Support pour boîtier prises

(Boîtier prises en option)

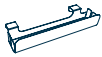

Bac de rangement

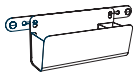

Jardinière

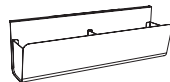

Plantes artificielles



Support pour écran



Tableau blanc avec plumier

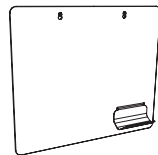

Lampe baladeuse

(Ampoule non fournie)



Collaborer / Flex office

Pour les nomades, une solution de coworking idéale. Assis ou debout, à vous de choisir !



Échanger & créer

La table NOMAD favorise les échanges et la créativité des équipes

Nuancier

Mélamine

Plateaux ép. 19 mm



MG

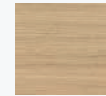

R1

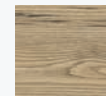

R3

Métal

Structure & piétements
Finition structurée

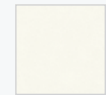

ZO



ZP

Métal

Accessoires
Finition lisse



SO



ZG



SG

TARIF P. 100

Détails et disponibilités

TOUTES LES RESSOURCES
EN LIGNE





Martin

L'ALLIÉ DES ESPACES AGILES

Pour brainstormer, partager ses idées, assister à une présentation, MARTIN est à l'aise en toute situation. A la fois mur multimédia, tableau blanc et espace de rangement, Il suffit de choisir son côté pour changer d'usage.

Fabriqué
en France



PEFC
PEFC/07-32-197





Assises et tables basses ZELIE, p. 22 - Cloisons & écrans SOLANGE, p. 122 - Bureaux ARIAL p. 86 - Table haute ARIAL, p. 164 - Sièges OSCAR 2, p. 228

Mobile, il se déplace facilement. Connecté, il intègre de manière discrète câbles et prises pour un espace ordonné. Un tableau mobile intelligent qui transforme n'importe quel espace en espace agile.



Points forts

3 modèles au choix :

1 face ou 2 faces avec rangement ou espace ouvert pour poufs



Mobile

4 roulettes avec freins (tous types de sol). Préhension par les montants



Connecté

Support écran intégré
Connexion via le passe-câble ou la prise intégrée au panneau frontal



Tableau blanc magnétique

Effaçable à sec, avec bande magnétique sur le haut



Zooms



Électrification discrète

Perforation de chaque côté pour sortir les câbles jusqu'à un enrouleur de fil (Version Tableau 2 faces)



Panneau amovible pour accéder aux câbles

Synoptique

Tableau 1 face

Multimédia avec plans de dépose



Tableau 2 faces

Avec rangement sécurisé



Avec espace ouvert pour poufs ZÉLIE

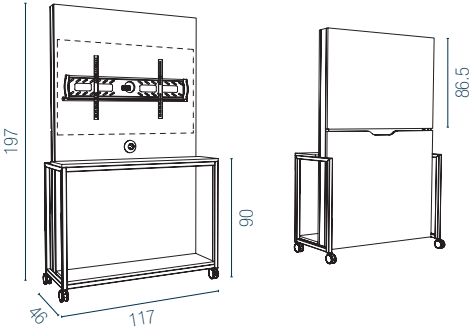
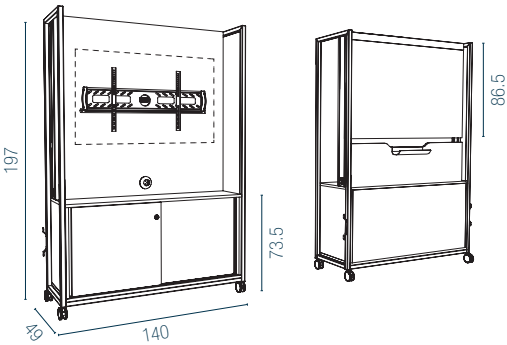
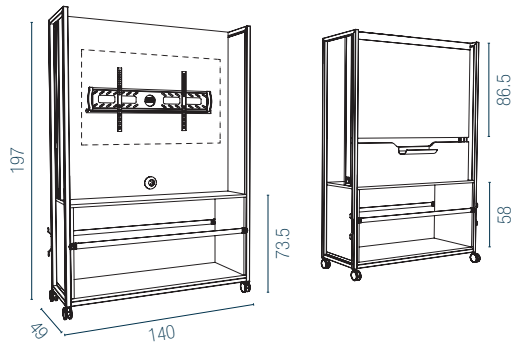

Recto : multimédia + rangement
(2 portes coulissantes)
Verso : tableau blanc

Recto : multimédia
Verso : tableau blanc
Espace ouvert accessible des 2 côtés
(pour poufs ZÉLIE vendus en option)

Zooms



Tableau blanc
avec auget intégré
(coordonné au coloris de la structure)



Sangle clipsable
Pour rangement des poufs ZÉLIE

Nuancier

Mélamine / Métal

Panneaux ép. 19 mm
(Rangement et tablettes) / Structure



MGZO



R9ZP

Mélamine

Panneau central



MG

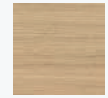

R1

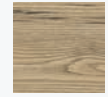

R3

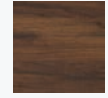

N6

TARIF P. 102

Détails et disponibilités

TOUTES LES RESSOURCES
EN LIGNE





Ping

Chaises SCOTT, p. 250 - Cloisons SOLANGE, p. 122

LA TABLE DE RÉUNION QUI CULTIVE L'ESPRIT SPORTIF

Sérieuse et ludique à la fois, la table PING transforme les moments de réunion en tournoi sportif ! Réunissant jusqu'à 6 personnes, elle se transforme en un clin d'œil en table de jeu grâce à son kit de ping-pong. Ses pieds en bois massif associés au plateau bleu apportent un style moderne et chaleureux aux espaces collectifs.

Fabriqué
en France



PEFC
PEFC/07-32-197





Points forts



Nuancier

Mélangé

Plateau ép. 19 mm



R6*

* Chants coloris blanc

Métal / Bois massif

Piètements



ZOMS



Tonalités colorées et naturelles

Pour créer une atmosphère propice à la détente et aux échanges



Robuste

Plateau mélaminé résistant aux chocs et aux rayures



Transformation rapide

Filet extensible avec montants ajustables selon l'épaisseur du plateau



Kit Ping-Pong inclus

(1 filet, 2 raquettes et 2 balles)



Zoom



Pied en hêtre massif

Insert métal associé au bois massif



Option



Rangement

Tiroir pour ranger le kit de ping-pong

TARIF P. 102

Détails et disponibilités

TOUTES LES RESSOURCES EN LIGNE





Chatbox

PLUS QU'UNE CABINE...UN CONCENTRÉ D'EFFICACITÉ !

CHATBOX est l'alternative aux salles de réunions classiques. Positionnées au cœur de l'espace collectif, peu encombrantes, ces cabines offrent aux collaborateurs un îlot confidentiel pour se concentrer, se réunir ou simplement téléphoner sans déranger les autres. Une solution innovante pour des espaces collectifs optimisés, plus sereins et productifs.





Points forts



Connectée

Électrification intégrée
(prise de courant fort
+ ports USB-A et USB-C)



Éclairage Led

avec détecteur de présence



Décorative

Panneaux latéraux métalliques
blanc ou noir (fixation aimantée)



Ventilation efficace et silencieuse

Du plafond vers le sol



Porte réversible

Ouverture droite ou gauche
(à choisir à l'installation)
Fermeture magnétique



Mobile

Le kit de déplacement permet
de déplacer votre cabine
en toute simplicité et sans
démontage (en option)



Zooms



Électrification intégrée

Prise de courant fort + ports USB-A
et USB-C

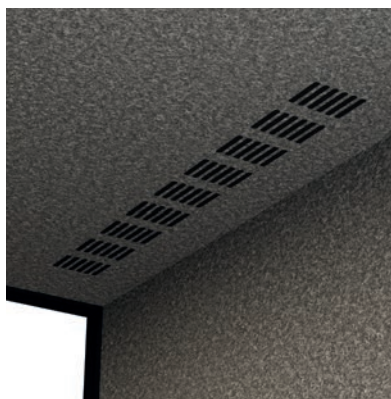

Ventilation intégrée

Discrète et silencieuse

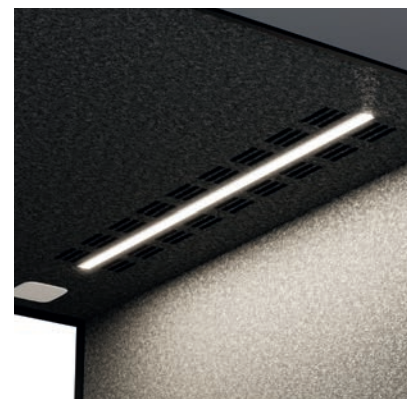

Éclairage LED

Avec détecteur de présence



Tables ARIAL, p. 164 - Chaises LOUIS, p. 244

**Exemples
de configurations**



Téléphoner

Ajoutez un tabouret pour offrir une assise active, le temps d'un échange téléphonique.



Se réunir

À 2, 4 ou 6 personnes, avec connectique intégrée pour ne pas perdre le fil !

Synoptique

Cabines

CB1



1 Avec tablette

CB2

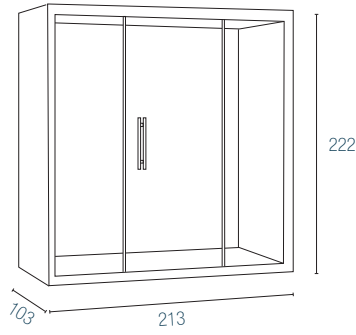

1-4 Nue
Avec table centrale / pied fixe

CB4

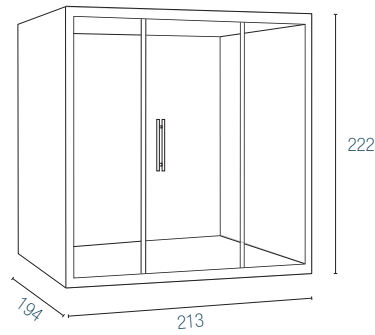

4-6 Nue
Avec table centrale / pied fixe

Options

Banquette 2 places



Table centrale



Support écran



Nuancier

Métal

Panneaux latéraux,
Piétements table
et chauffeuse



SO



SG

Tissu

Banquettes



FU

TARIF P. 103

Détails et disponibilités

TOUTES LES RESSOURCES
EN LIGNE





Emi

Un style unique

Design des chaises et table assorti

Sens du détail

Piètement et roulettes chromés
Chant noir assorti au voile de fond

Stockage optimisé

Table abattante à l'horizontale

Mobile

Roulettes sol souple et dur

Nuancier

Méla mine

Plateau blanc/chant noir
ép. 25 mm



MM

Métal

Piètement



SQ

 Chaises EMI assorties à la table Cf. p.254

TARIF P. 130

Détails et disponibilités

TOUTES LES RESSOURCES
EN LIGNE



Fabriqué en France



PEFC
PEFC/07-32-197





Nuancier

Mélangé

Plateaux ép. 25 mm

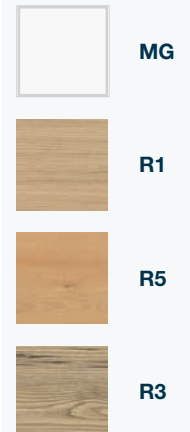

Métal

Piètements



Tables pliantes

Rangement facilité

Manipulation facile et rapide pour plier les tables

Stockage optimisé

Chariot en option idéal pour le transport et le stockage.
Capacité :

10 tables pliantes,
20 chaises collectivité 4 pieds
ou 14 chaises pliantes

Modulaires

Tables rectangulaires et demi-lune (Plateaux coins arrondis)

Synoptique

Tables rectangulaires

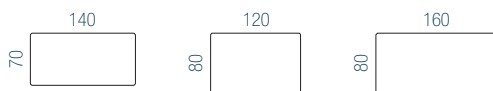

Tables demi-lune

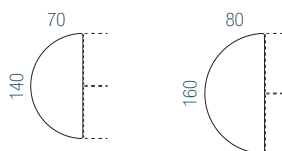

Zooms



Exemple de configuration



TARIF P. 104

Détails et disponibilités

TOUTES LES RESSOURCES EN LIGNE



Poignée de déblocage pour plier les pieds

Les tables combinées deviennent une table de réunion

Fabriqué en France



PEFC
PEFC/07-32-197





Tables polyvalentes

Chaises ANTHRA+, p. 247

Synoptique

Tables rectangulaires



Tables demi-lune

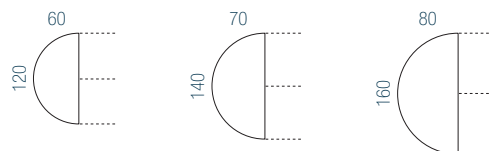

Tables trapèze



Fabriqué en France





Points forts

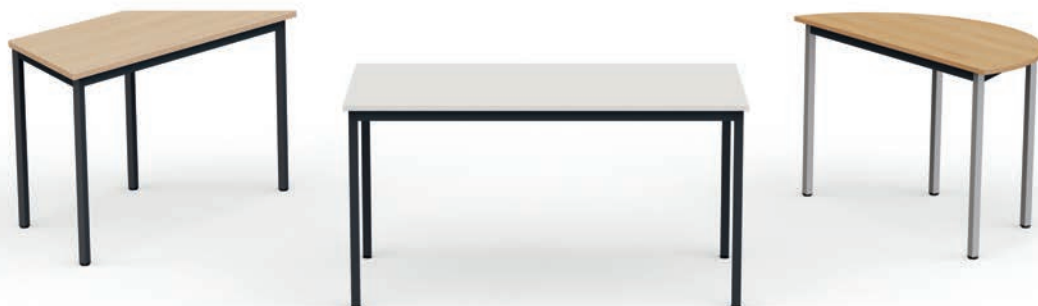

Économique et modulable

Aménager des salles de travail ou de réunion à faible coût

Configurations variées

Plans droits, demi-lune ou trapèze

Piètement

En métal section carrée 30x30 mm
Pieds disponibles en 3 coloris
Cadre porteur anthracite lisse
Pieds équipés de vérins de mise à niveau

Nuancier

Mélangé

Plateaux ép. 19 mm



MG



R1



R5

Métal

Pieds



SO



SA



SC



Multiples configurations



Table carrée

4 Plans droits



Table en U

4 Plans droits et 3 Plans trapèze



Table ovale

2 Plans droits et 2 Plans demi-lune

TARIF P. 105

Détails et disponibilités

TOUTES LES RESSOURCES EN LIGNE





Tables abattantes

Chaises ROMY, p. 256 -
Tableau mobile MARTIN, p. 192

MODULAIRES & ASTUCIEUSES

Idéales pour les espaces de formation et réunion, les tables abattantes transforment l'espace. Elles s'utilisent seules ou reliées entre elles, puis se rangent rapidement grâce à leur plateau rabattable. Stockées, elles sont emboîtées les unes derrière les autres pour optimiser l'espace. Disponibles en version plateau nu ou découpé pour trappe, elles s'adapteront à tous vos besoins.

Fabriqué
en France





Points forts



Multi-espace

Idéal pour les espaces de réunion ou formation



Modulable & Reconfigurable

Un système simple et rapide pour faciliter la reconfiguration des espaces

Différents formats de plateaux : plans droits, avec angle 90° intégré et plans demi-lune



Mobile

4 roulettes noires avec freins (tous types de sols)



Zooms



Basculement rapide et sécurisé

Barre de déblocage sous le plateau pour ranger les tables



Stockage optimisé

Rangement par emboîtement en position basculée



Assemblage facile et rapide sans outils

Kit de liaison inclus fixé par boutons moletés



Chaises ROMY, p. 256 - Cloisons SOLANGE, p. 122-

Options



Électrification via une trappe

Plateau découpé pour trappe soft closing simple accès



Goulotte L. 50 cm incluse sous la trappe pour boîtier prises



Voile de fond en tissu

Se rabat sous le plateau une fois la table pliée

Synoptique

Tables rectangulaires Table ovale

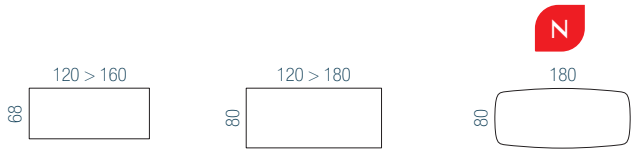

Connectique

Trappe simple accès
(hors table ovale)

Extensions pour tables rectangulaires

Plans demi-lune

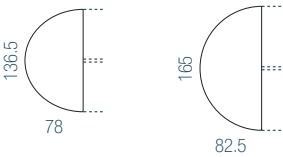

Plans droits avec angle 90° intégré

(Angle à droite ou à gauche)

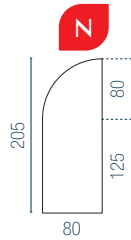

Options

Voiles de fond tissu

(Tables rectangulaires et extensions plans droits avec angle 90° intégré)

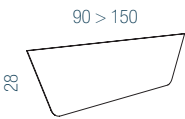

Multiples configurations



Tables individuelles

Rectangulaire ou ovale.
Différents formats et dimensions



Tables configurées

2 plans rectangulaires
et 2 plans demi-lune

Nuancier

Mélanges

Plateaux ép. 25 mm

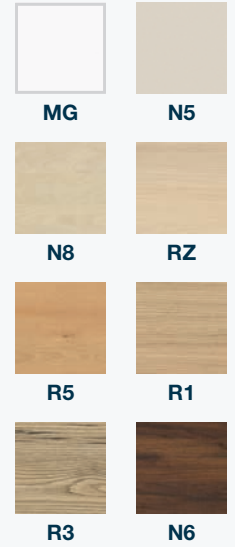

Métal

Piétements

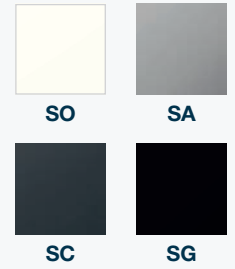

Tissu

Voiles de fond



TARIF P. 106

Détails et disponibilités

TOUTES LES RESSOURCES
EN LIGNE





Éloise

NOUVEAU

SE RESTAURER, SE RÉUNIR DE TOUTES LES FAÇONS !

Idéales pour aménager vos espaces de réunion et/ou de restauration, les tables ELOISE vous offrent un large choix de piétements, de plateaux et de finitions.

Fabriqué
en France





Chaises & tabourets GELATI, p. 258 - Assises ANOUK, p. 28

Alliant simplicité des lignes et praticité, cette gamme répondra à tous vos besoins d'aménagement. Multi-espaces et multi-usages, ELOISE offre de nombreuses solutions autant pour vos salles de restauration & détente que comme simple table de réunion.



Chaises LOUIS, p. 244- Rangements KARL, p. 80

Exemples de configurations



Idéal pour les pauses café, un mange debout disponible en plateau rond ou carré



Se réunir jusqu'à 8 personnes.
Une table 4 pieds grand format disponible en 2 dimensions



Points forts



Formes et piétements variés

Tables carrées, rondes, rectangulaires et tonneau
Pied central ou 4 pieds.



Choix des postures

Des versions hautes pour les pauses café
ou plus standard



Choix des matières

Stratifié ou mélaminé



Synoptique

Tables H. 73.5 cm

Rondes*



Carrées*

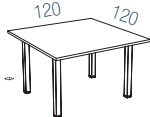
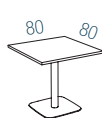

Tonneau

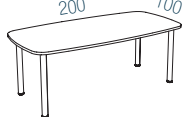
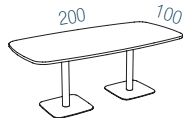

Rectangulaires

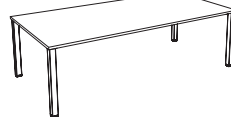

Connectique

Tables tonneau
& rectangulaires



Trappe double accès

Mange debout H. 104.5 cm

Rondes*



Carrées*

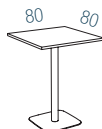

* Disponible en mélaminé et stratifié

Nuancier

Mélaminé

Plateaux ép. 25 mm



MG



N5



R9

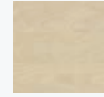

N8



RZ

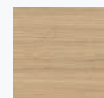

R1



R5

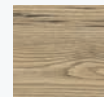

R3

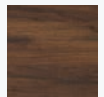

N6

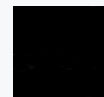

RK

Stratifié

Plateaux ép. 25 mm

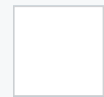

HZ



VW

Métal

Piétements

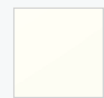

SO

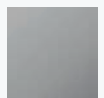

SA



SC



SG



Plus de choix
disponibles

TARIF P. 107

Détails et disponibilités

TOUTES LES RESSOURCES
EN LIGNE





Élisa

NOUVEAU

Tabourets SOFIA, p. 264

TRAVAILLER OU SE RÉUNIR

ELISA offre une gamme de tables hautes, disponibles en 2 profondeurs. En version P. 40 cm, c'est une console idéale pour travailler grâce à la connexion sur plateau. En version plus profonde, elle est parfaite pour se réunir ou partager un moment de détente.

Synoptique

Tables hautes H. 105 cm

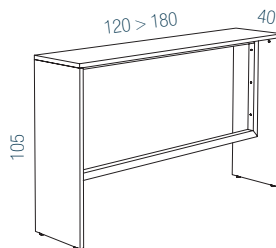
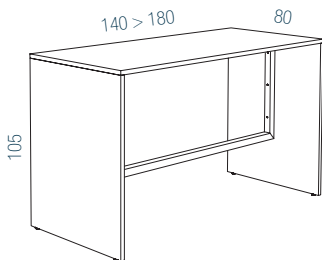

Fabriqué en France





Points forts



Robuste et confortable

Pieds panneaux avec cadre en métal structural pouvant servir de repose-pieds. Vérins de mise à niveau.



1 hauteur, 2 profondeurs

Table haute pour un usage solo ou à plusieurs. Différentes longueurs de plateaux.



Électrification optimisée

Gestion horizontale et verticale des câbles (tables P. 40 cm)



Zooms



Électrification sur plateau

Plateaux pré-perçés pour obturateurs optionnels avec connexion directe (uniquement tables P. 40 cm)



Gestion verticale des câbles

Carter aimanté à positionner sur le cadre en métal

Nuancier

Mélangé

Plateaux, piétements ép. 25 mm



MG



R9

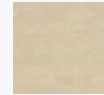

N8



RZ

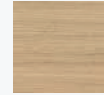

R1



R5

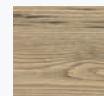

R3

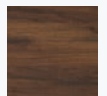

N6

Métal

Cadre



SO

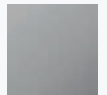

SA

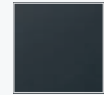

SC



SG



Plus de choix disponibles

TARIF P. 109

Détails et disponibilités

TOUTES LES RESSOURCES
EN LIGNE





Évasion

Assises et tables basses MARGOT, p. 34

POUR UN ESPACE NATUREL !

Alliance subtile du métal et du hêtre massif, la gamme ÉVASION séduit grâce à ses lignes graphiques et élancées. Complète, elle propose des tables et des assises coordonnées. Disponible en plusieurs formes et dimensions, ÉVASION s'adapte aussi bien aux espaces de restauration qu'aux espaces de réunion.

Synoptique

Tables H. 73.5 cm

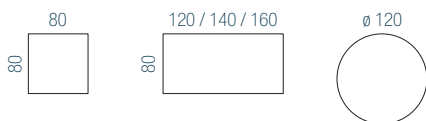

Tables H. 110 cm



Fabriqué
en France



ÉVASION existe aussi en chaises
et tabourets p. 266 et table basse p. 47



Points forts



Style naturel

Pieds en hêtre massif



Configurations variées

Tables rondes, carrées ou rectangulaires



Varié les postures

Des versions hautes (H. 110 cm) ou H. 73.5 cm



Résistants & lavables

Plateaux stratifiés résistants aux tâches et aux rayures



Zooms



Insert métal associé au bois massif

Blanc ou noir, il apporte un style moderne à votre table



Chant multiplis

Décor hêtre

Nuancier

Stratifié

Plateaux ép. 25 mm
Chants multiplis



HZ



VW

Métal/Bois massif

Piètements
Finition structurée



ZOMS



ZPMS

Piètements
Finition lisse



SOMS



SGMS

TARIF P. 110

Détails et disponibilités

TOUTES LES RESSOURCES
EN LIGNE





Lucie

Chaises SCOTT, p. 250

POLYVALENTE ET COLOREE

LUCIE est la table idéale pour équiper vos espaces de détente et de restauration. Disponible en différents formats et dimensions, elle se décline dans une multitude de coloris et matières pour s'adapter à tous vos styles.

Fabriqué
en France





Points forts



Choix des versions

Disponible en hauteur standard ou table haute, plateaux ronds ou carrés



Usage Indoor & Outdoor

Plateau mélamine, pied métal (Indoor)

Plateau et piétement métal, traités anticorrosion (Outdoor)



Synoptique

Tables Indoor

Existe en H. 73.5 et 104.5 cm

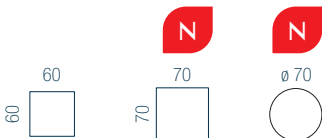

Tables Outdoor

Existe en H. 73.5 et 104.5 cm

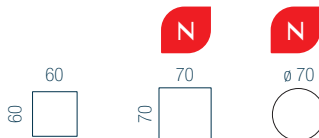

Nuancier Tables Indoor

Mélamine

Plateaux ép. 25 mm



MG



N5

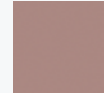

R8



R7



R9

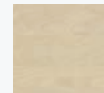

N8



RZ

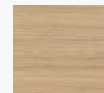

R1



R3

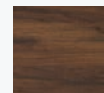

N6

Métal

Piétements



ZP

Tables Outdoor

Métal

Plateaux ép. 3 mm /
Piétements



ZPSG

TARIF P. 111

Détails et disponibilités

TOUTES LES RESSOURCES
EN LIGNE





Gaby

NOUVEAU

DESIGN & RETRO

Imaginée par notre Studio Design, GABY est idéale pour aménager vos espaces de restauration. Avec son look bistrot, elle se distingue par son style unique et chaleureux. Composée de tables, chaises et tabourets déclinés en plusieurs finitions, GABY crée une ambiance conviviale et authentique.

Fabriqué
en France





Points forts



Look bistrot

Parfait pour aménager vos espaces de restauration



Gamme complète

Tables disponibles en 2 hauteurs
Chaises et tabourets assortis



Variété des matières et coloris

En mélamine et stratifié



Synoptique

Tables H. 74 cm



Tables H. 105 cm

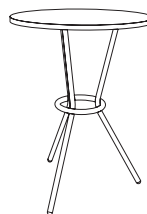

GABY existe aussi en chaises et tabourets p. 262

Nuancier

Mélamine

Plateaux ép. 25 mm



MG



N5



R8



R7



R9

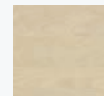

N8

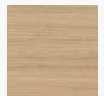

R1

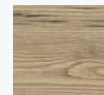

R3

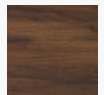

N6

Stratifié

Plateaux ép. 25 mm

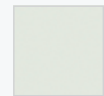

HZ



VW

Métal

Piètements



ZP

TARIF P. 110

Détails et disponibilités

TOUTES LES RESSOURCES
EN LIGNE





Assises



Sièges de travail



Mia

Page 226 ›

.....



Alter

Page 227 ›

.....



Oscar 2 NOUVEAU

Page 228 ›

.....



Léon

Page 230 ›

.....



Gabin NOUVEAU

Page 232 ›

.....



Opus

Page 233 ›

.....



Elliott

Page 234 ›

.....



Manhattan

Page 236 ›

.....



Attitud

Page 237 ›

.....



Seven

Page 238 ›

.....



24H Pro

Page 239 ›

.....



Polyuréthane

Page 239 ›

.....



Pour savoir bien régler son siège,
retrouvez tous nos conseils sur notre site
en flashant ce QR Code

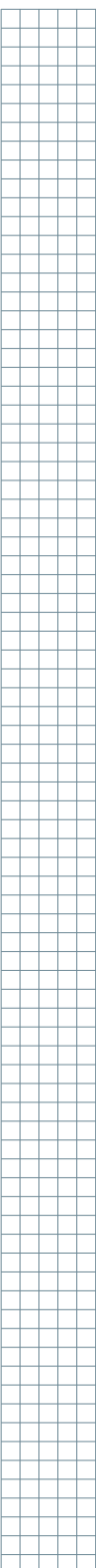



Mia



Confort du dos

Dossier réglable en hauteur (+5 cm)
et en profondeur (+3 cm)



Mécanisme contact permanent

Système d'articulation ergonomique
où le dossier suit les mouvements
du dos, l'assise restant fixe.



Choix des options

Avec ou sans accoudoirs

Nuancier

Tissu

Assise et dossier



BI
Noir



BE
Bleu



SV
Noir

Nylon

Piétement

Mécanisme

Contact permanent



TARIF P. 114

Détails et disponibilités

TOUTES LES RESSOURCES EN LIGNE





Alter



Confort du dos

Dossier tissu réglable en hauteur (+7 cm)
Blocage du dossier : 4 positions (dossier tissu)
et 3 positions (dossier résille)
Réglage de la tension du dossier par une molette frontale



Mécanisme synchrone

Système d'inclinaison synchronisé
du dossier et de l'assise



Accoudoirs

Fixes ou 1D

Nuancier

Tissu

Assise et dossier

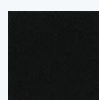

KE
Noir



KC
Bleu



TI
Noir

Nylon

Piètement



SV
Noir

Mécanisme

Synchrone



TARIF P. 114

Détails et disponibilités

TOUTES LES RESSOURCES EN LIGNE





Oscar 2

NOUVEAU

Bureaux et tables ARIAL, p. 86/164 -
Ecrans et cloisons SOLANGE, p. 122

Zooms



Accoudoirs
1D ou 4D



Soutien lombaire réglable
Résille : + 7,5 cm
Tissu : + 5 cm



Dossier design
Un cadre aux lignes arrondies

Fabriqué
en France



Hors accoudoirs



Points forts



Confort du dos

Dossier en tissu ou en résille fixe, avec soutien lombaire réglable intégré



Posture haute

Version dessinateur



3 Mécanismes

Synchrone autorégulé
Synchrone confort
Synchrone ergonomique avec translation d'assise



2 types de dossiers



Dossier tissu



Dossier résille

Nuancier

Tissu

Assise et dossier



Cat. A
Bondaï



Cat. B
Step
Step mélange
Chili



Cat. C
Secret

Polypropylène

Dossier

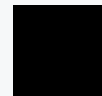

Noir

Résille

Dossier

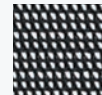

IW
Noir

Nylon / Aluminium

Piètement



SV
Noir



SQ
Chromé

Mécanismes

Synchrone



- Autorégulé
- Confort
- Ergonomique avec translation d'assise

TARIF P. 115

Détails et disponibilités

**TOUTES LES RESSOURCES
EN LIGNE**





Léon

Bureaux ARIAL, p. 86 - Ecrans SOLANGE, p. 122 - Tower GUSTAVE, p. 138 - Rehausses, p. 135

3 types de dossiers



Dossier tapissé

Avant / arrière



Dossier tissu

Avant tapissé, arrière polypropylène



Dossier résille

Fabriqué en France

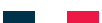

Hors accoudoirs



Points forts



Confort du dos

Réglage en hauteur intuitif des dossiers (+6 cm)

Soutien lombaire intégré au dossier
résille (+6 cm)



Confort de l'assise

Un confort ferme
(assise moulée, ép. + 4 cm)



Mécanismes

Synchrone ergonomique
avec translation d'assise
Synchrone latéral



Zooms



Accoudoirs

1D ou 4D



Poignées latérales

Pour réglage en hauteur du dossier

Nuancier

Tissu

Assise et dossier



Cat. A
Bondai



Cat. B
Step
Step mélange
Chili



Cat. C
Secret

Polypropylène

Dossier



Noir

Résille

Dossier



HB
Noir

Nylon / Aluminium

Piètement



SV
Noir



SQ
Chromé

Mécanismes

Synchrone



- Latéral
- Ergonomique avec
translation d'assise

TARIF P. 116

Détails et disponibilités

**TOUTES LES RESSOURCES
EN LIGNE**





Gabin

NOUVEAU

- Confort du dos**
 Dossier résille fixe avec soutien lombaire réglable intégré (+ 6,5 cm)
- Confort de l'assise**
 Assise au galbe accentuée à l'avant pour favoriser la circulation sanguine
- Choix des options**
 Tête réglable en hauteur
 Accoudoirs 1D ou 4D
- Mécanismes**
 Synchrone confort
 Synchrone ergonomique avec translation d'assise

Nuancier

Tissu

Assise



Cat. A
BONDAÏ



Cat. B
STEP
STEP MÉLANGE



Cat. C
SECRET



Cat. E
CUIR

Résille

Dossier



IL
Noir

Nylon / Aluminium

Piètement



SV
Noir



SQ
Chromé

Mécanismes

Synchrone



- Confort
- Ergonomique
avec translation
d'assise

TARIF P. 117

Détails et disponibilités

TOUTES LES RESSOURCES
EN LIGNE



Fabriqué
en France



Hors accoudoirs



Opus

Confort du dos

Réglage en hauteur par crémaillère (+ 6 cm)
Soutien lombaire optionnel pour le dossier résille uniquement (+11cm)

Confort de l'assise

Une assise large et confortable (51 cm)

Confort de la nuque

Têteière inclinable (45°) et ajustable (+6 cm)

Version "Ergo +" pour plus de confort

Assise négative
Accoudoirs chromés pivotants à 360°
Amplitudes de réglages de l'assise plus importantes

Nuancier

Tissu

Assise et dossier



Cat. A
BONDAÏ



Cat. B
STEP
STEP MÉLANGE
CHILI



Cat. C
SECRET



Cat. E
CUIR

Résille

Dossier



IZ
Noir

Nylon / Aluminium

Piètement



SV
Noir



SQ
Chromé

Mécanismes

Synchrone



- Confort
- Ergonomique
- Ergo + avec translation d'assise

TARIF P. 118

Détails et disponibilités

TOUTES LES RESSOURCES EN LIGNE



Fabriqué en France



Hors accoudoirs



Eliott

Bureaux ROBIN, p. 100 - Ecrans SOLANGE, p. 122

3 types de dossiers



^
Dossier résille



^
Dossier tissu
(haut ou bas dossier)



^
Dossier matelassé

Fabriqué
en France



Hors
accoudoirs





Points forts



Posture haute

Version dessinateur



Confort du dos

Dossier tissu ou résille fixe avec soutien lombaire réglable intégré (+6 cm)



Confort de l'assise

Un confort ferme (assise moulée ép. 4 cm)



Mécanismes

Synchrone autorégulé avec translation d'assise
Synchrone latéral avec translation d'assise



Zooms



Accoudoirs 3D

Manchette soft touch



Translation d'assise intégrée

Bouton de réglage sur l'assise

Nuancier

Tissu

Assise et dossier



Cat. A

Bondaï



Cat. B

Step
Step mélange
Chili



Cat. C

Secret



Cat. E

Cuir

Polypropylène

Dossier

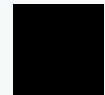

Noir

Résille

Dossier



IW
Noir

Nylon / Aluminium

Piètement



SV
Noir



SQ
Chromé

Mécanismes

Synchrone



- Autorégulé
- Latéral
- Translation systématique intégrée à l'assise

TARIF P. 119

Détails et disponibilités

TOUTES LES RESSOURCES
EN LIGNE





Manhattan

Confort de la nuque

Têteière fixe, offrant une grande largeur pour assurer un bon maintien des cervicales

Mécanisme basculant décentré

Système basculant : dossier et assise pivotent ensemble

Détails des finitions

Accoudoirs fixes chromés avec manchettes souples

Nuancier

Cuir

Vachette pleine fleur
Assise et dossier



YB
Noir

Mécanisme

Basculant décentré (siège)



TARIF P. 120

Détails et disponibilités

TOUTES LES RESSOURCES EN LIGNE





Attitud



Confort

Assise : large et confortable (52 cm)
 Dos : dossier réglable en hauteur (+6cm)
 Nuque : tête fixe, de grande largeur, pour un bon maintien des cervicales



Détails des finitions

Dossier tapissé des 2 côtés
 Accoudoirs 4D avec manchettes soft touch



Mécanisme synchrone ergonomique avec translation d'assise

Réglage ergonomique de la tension du dossier via une manette latérale

Nuancier

Cuir

Assise et dossier



YB
Noir

Tissu

Assise et dossier



Cat. A
BONDAÏ



Cat. B
STEP
STEP MÉLANGE
CHILI



Cat. C
SECRET

Nylon / Aluminium

Piètement



SV
Noir



SQ
Chromé

Mécanisme

Synchrone



Ergonomique avec translation d'assise

TARIF P. 120

Détails et disponibilités

TOUTES LES RESSOURCES EN LIGNE



Fabriqué en France





Seven

Confort de l'assise

Mousse moelleuse
(assise ép. 50 mm)

Confort de la nuque

Tête fixe, offrant une grande
largeur pour assurer un bon
maintien des cervicales

Mécanisme basculant décentré

Système basculant : dossier et assise
pivotent ensemble

Accoudoirs

Fixes chromés

Nuancier

Cuir

Siège de travail



YB
Noir

Simili cuir

Chaise



YA
Noir

Aluminium

Piétement



SQ
Chromé

Mécanisme

Basculant décentré



TARIF P. 120

Détails et disponibilités

**TOUTES LES RESSOURCES
EN LIGNE**



24H Pro



Usage intensif

Siège 24/7



Tissu haute résistance



Accoudoirs

Fixes chromés avec manchettes tapissées



Supporte jusqu'à 160 kg



Mécanisme basculant décentré

Système basculant : dossier et assise pivotent ensemble

Nuancier

Tissu

Assise et dossier



UD
Noir

Mécanisme

Basculant décentré



TARIF P. 121

Détails et disponibilités

TOUTES LES RESSOURCES
EN LIGNE



Polyuréthane



Assises spécifiques en polyuréthane

Forte résistance aux taches, agressions chimiques ou étincelles pour laboratoires et ateliers



Gamme complète

Siège dessinateur avec repose-pieds fixe

Siège de travail

Tabouret



Patins antidérapants

Possible avec le siège dessinateur et tabouret

Nuancier

Polyuréthane

Assise et dossier



PA
Noir

TARIF P. 121

Détails et disponibilités

TOUTES LES RESSOURCES
EN LIGNE



Fabriqué
en France



Chaises & tabourets



Inventiv'

Page 242 ›

.....



Isabel

Page 243 ›

.....



Louis NOUVEAU

Page 244 ›

.....



Meeting+

Page 246 ›

.....



Anthra+

Page 247 ›

.....



Géo

Page 247 ›

.....



Rosalie

Page 248 ›

.....



Scott NOUVEAU

Page 250 ›

.....



Emi

Page 254 ›

.....



Romy

Page 256 ›

.....



Gelati

Page 258 ›

.....



Line

Page 260 ›

.....



Gaby NOUVEAU

Page 262 ›

.....



Sofia NOUVEAU

Page 264 ›

.....



Évasion

Page 266 ›

.....

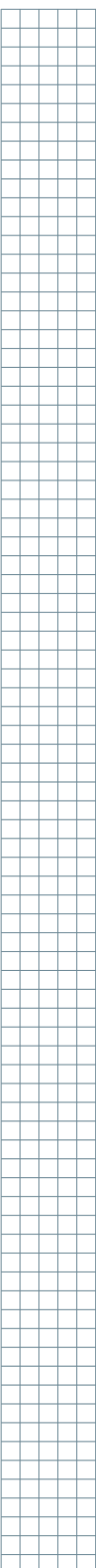

Nuancier

Tissu

Assise et dossier



Cat. A
Bondai



Cat. B
Step
Step mélange
Chili



Cat. C
Secret

Résille

Dossier



UH
Noir



UM
Blanc

Métal

Piétement

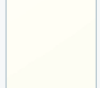

SP
Blanc



SB
Gris



SG
Noir

Inventiv'



Multi-espace

Espace de travail,
réunion ou formation



Dossier tissu ou résille

Un choix esthétique
et de confort (dossier résille
plus respirant)



Douceur des lignes

Pieds légèrement galbés



Finitions variées

Résille blanche ou noir
3 couleurs de piétement



Zooms



Accoudoirs avec tablette écrivain

À droite



Chariot de transport

Il permet d'empiler jusqu'à 6 chaises
4 pieds

TARIF P. 124

Détails et disponibilités

TOUTES LES RESSOURCES
EN LIGNE



Fabriqué
en France



4 pieds
fixe



Avec tablette
écrivain



Luge



GARANTIE
2
ans



35
%

Isabel



^
Dossier tissu ou résille
 Un choix esthétique et de confort (dossier résille plus respirant)

^
Confort ferme et durable
 (mousse moulée ép. 50 mm)

^
Détails des finitions
 Dossier tapissé des 2 côtés

Types de piétements



^
Piètement 5 branches sur roulettes, avec mécanisme basculant.

^
Piètement 4 branches (croix)

Fabriqué en France



Luge

Nuancier

Tissu

Assise et dossier



Cat. A
Bondai



Cat. B
Step
Step mélange
Chili



Cat. C
Secret

Cuir

Assise et Dossier



YB
Noir

Résille

Dossier



IN
Noir

Métal

Piètement



SB
Gris
aluminium



SG
Noir



SQ
Chromé

TARIF P. 125

Détails et disponibilités

TOUTES LES RESSOURCES EN LIGNE





Louis

NOUVEAU

Tables ARIAL, p. 164 - Lampes AVA, p. 272

SOBRE ET CONFORTABLE

Disponible en deux versions, 5 branches sur roulettes et piétement luge, LOUIS s'adapte parfaitement à tous les espaces de travail et de réunion. C'est la solution idéale pour allier esthétique et fonctionnalité.

Fabriqué
en France





Points forts



Multi-espace

Espace de travail ou réunion



Stockage optimisé

Légère, la version luge se transporte et s'empile facilement (jusqu'à 3 pièces)



Réglable

Amplitude du réglage en hauteur de +11 cm (piétement roulettes)



2 piétements



Piétement luge



Piétement 5 branches sur roulettes

Nuancier

Tissu

Assise



Cat. A
Bondai



Cat. B
Step
Step mélange
Chili



Cat. C
Secret

Résille

Dossier



TI
Noir

Nylon

Piétement



SV
Noir

Métal

Piétement

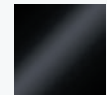

SG
Noir

TARIF P. 126

Détails et disponibilités

**TOUTES LES RESSOURCES
EN LIGNE**



Nuancier

Polypropylène

Assise

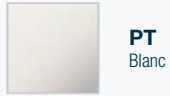

PT
Blanc



PY
Anthracite

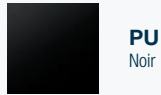

PU
Noir



PZ
Rouge



PC
Vert sapin

Métal

4 pieds



SQ
Chromé

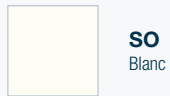

SO
Blanc



X1
Anthracite



SG
Noir



ZY
Rouge



SW
Vert sapin

Meeting+



Colorées

5 couleurs d'assises au choix sur piétement chromé ou de couleur assortie à la coque



Légères

Elles se transportent et s'empilent facilement* (jusqu'à 15 pièces)



Non feu

Coque M2 (en option)



Tablette écrivain

(en option)

TARIF P. 126

Détails et disponibilités

TOUTES LES RESSOURCES
EN LIGNE



sans
accoudoirs

avec tablette
écrivain

Anthra+



Multifonction

Elle s'accessorise facilement



Dossier au choix

Tissu ou résille



Empilable

Jusqu'à 12 pièces



Options

Avec ou sans accoudoirs
Avec ou sans accoudoirs avec tablette écrivain



sans accoudoir
sans tablette
écrivain



avec accoudoir
sans tablette
écrivain



Géo



Pliante



Polyvalente



Tablette écrivain rotative



Dossier et assise au choix

Tissu ou simili cuir



Nuancier

Tissu

Assise et dossier



Cat. A
Bondai



Cat. B
Step

Résille

Dossier



TI
Noir

Métal

Piètement



SB
Gris



SG
Noir

TARIF P. 127

Détails et disponibilités

TOUTES LES RESSOURCES EN LIGNE



Nuancier

Tissu

Assise et dossier / Piètement



FA/SG
Noir céleste/
Noir



FG/SG
Gris orage/
Noir

Simili cuir

Assise et dossier / Piètement



YA/SQ
Noir/Chromé

TARIF P. 127

Détails et disponibilités

TOUTES LES RESSOURCES EN LIGNE





Rosalie

Table ELOISE, p. 210 - Table haute ELISA, p. 214 -
Poubelle, p. 278

CHAISE LUDIQUE & POLYVALENTE

Alliant confort, praticité et un large choix de piétement, ROSALIE est idéale aussi bien pour les espaces de restauration, formation, accueil de visiteur, réunion et brainstorming.

Fabriqué
en France



4 pieds
métal



Traineau



2
ans



43
%



Points forts



Facile à déplacer
Prise de main intégrée à la coque

Version campus
Une version tout en un avec tablette écri-
toire pivotante à 360° et dépose
sac intégré

Multi-espace
Espace de travail,
réunion ou formation

**Assise enveloppante
et confortable**
Placet d'assise
(en option)



Zooms



Manette de réglage de la hauteur
Piétement 5 branches sur roulettes : + 13 cm



**Tablette écri-
toire**

Nuancier

Tissu

Placet d'assise



Cat. A
BONDAT



Cat. B
STEP
STEP MÉLANGE
CHILI



Cat. C
SECRET



Cat. D
FENICE

Polypropylène

Assise



PS
Blanc crème



PQ
Gris



PJ
Jaune

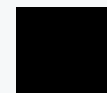

PR
Noir

Métal

Piétement



SQ
Chromé

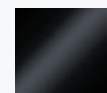

SG
Noir

TARIF P. 128

Détails et disponibilités

**TOUTES LES RESSOURCES
EN LIGNE**





Scott

NOUVEAU

UNE ASSISE COSY ET MULTIUSAGE

Grâce à son dossier enveloppant, SCOTT apporte un grand confort d'assise et habille avec élégance les espaces.

Fabriqué
en France





Tables hautes ELISA, p.214 - Tabourets GELATI, p.258 - Tables LUCIE, p.218

Disponible en version 4 pieds en polypropylène, en bois, en fibre de bois ou en version 5 branches sur roulettes, avec 7 couleurs de coques au choix dont 3 issus de matériaux 100% recyclés, SCOTT permet de répondre à tous les espaces et styles. SCOTT est également proposé en version entièrement tapissée, disponible dans 50 tissus.



Bureaux ROBIN, p. 76 - Lampes OL02 p. 272

Zooms



^
Piètement bois



^
**Piètement en fibre de bois
ou en polypropylène (noir)**



^
**Piètement 5 branches
sur roulettes**



Points forts



Multi-espace

Espace de travail,
restauration, réunion
ou informel

Personnalisable

Coque polypropylène
ou entièrement tapissée
7 couleurs de coque
avec placet d'assise (en option)
50 tissus disponibles
4 types de pieds

Durable

1 catégorie de tissu CHILI
100% polyester recyclé
3 nuances issues
de matériaux 100% recyclés

Nuancier

Tissu

Assise*, dossier* et placet
d'assise



Cat. A
Bondai



Cat. B
Step
Step mélange
Chili



Cat. C
Secret



Cat. D
Fenice
Cyber

* Sauf CAT C Secret

Polypropylène

Assise



PB
Neige



QW
Taupe



PM
Rose poudré



PN
Turquoise

Polypropylène recyclé

Assise



OQ
Noir



OZ
Gris clair



O9
Brique

TARIF P. 129

Détails et disponibilités

**TOUTES LES RESSOURCES
EN LIGNE**





Emi

Tables ARIAL, p.164

ELLE SE PLIE À VOS ENVIES !

EMI a été spécialement conçue pour créer des espaces flexibles et polyvalents. Sa conception ingénieuse lui permet de reconfigurer les espaces avec une étonnante facilité. Ses assises fixes ou mobiles se déplacent avec légèreté. Il suffit d'un geste pour basculer les tables, plier les chaises afin de les ranger. Empilable horizontalement et verticalement jusqu'à 20 pièces, EMI optimise les espaces de stockage.

Fabriqué
en France



Assises en poly-
propylène pieds
fixes ou roulettes



Assise
tapisée
pieds fixes



Assise
tapisée
pieds roulettes





Points forts



Multi-espace

Espace de travail, réunion ou formation



Options multiples

Assises fixes ou rabattables
Avec ou sans accoudoirs
Avec ou sans roulettes



Confort immédiat

Mousse moulée ép. 20mm

Nuancier

Tissu

Assise



Cat. A
BONDAI



Cat. B
STEP
STEP MÉLANGE
CHILI



Cat. C
SECRET

Polypropylène

Assise et dossier



PU
Noir

Résille

Dossier



UH
Noir

Métal

Piètement



SQ
Chromé



Empilables à la verticale & à l'horizontale



TARIF P. 130

Détails et disponibilités

TOUTES LES RESSOURCES EN LIGNE



EMI existe aussi en table p. 202



Romy

LA CHAISE RESPONSABLE ET MODERNE

A l'origine de ROMY, une conception innovante qui permet un assemblage sans vis et sans outils de la chaise par un système de verrouillage modulaire. Une solution intelligente qui facilite son recyclage tout en lui apportant une versatilité d'usages et de couleurs. Mobile ou fixe, avec ou sans accoudoirs, avec ou sans tablette, ROMY se personnalise à l'envi. Enfin, la forme de l'assise et du dossier a été dessinée spécifiquement pour apporter un confort immédiat à son utilisateur.

Fabriqué
en France



Assise
polypropylène



Assise
tapissée



Assise
polypropylène



Assise
tapissée





Points forts



Confort immédiat

Une assise large avec un dossier enveloppant

Pratique

Chaise résistante, lavable
Empilable jusqu'à 15 chaises sur chariot

Tablette amovible

Sans outils



Options



Pièces d'accroche

Pour chaise sans accoudoirs



Pièces d'accroche

Pour chaise avec accoudoirs

Nuancier

Tissu

Placet d'assise



Cat. A
Bondai



Cat. B
Step
Step mélange
Chili



Cat. C
Secret

Polypropylène

Dossier, assise, accoudoirs



PX
Gris



PT
Blanc



PU
Noir



PW
Jaune



PZ
Rouge

Métal

Piètement



SB
Gris



SP
Blanc



SG
Noir



SX
Jaune



ZY
Rouge

* Couleur des assises, des dossiers et des accoudoirs, toujours identiques - Possibilité de varier la couleur du piètement.

TARIF P. 132

Détails et disponibilités

TOUTES LES RESSOURCES EN LIGNE





Gelati

Tables ARIAL, p.164

LA CHAISE CONTEMPORAINE

GELATI est une chaise au style contemporain qui s'intègre facilement dans tous les espaces. Son assise légère, traitée anti-UV, permet un usage en intérieur comme en extérieur. Disponible en version chaise ou tabouret, elle complète autant les tables restauration que les tables projets des espaces de travail.



Chaises



Tabourets





Points forts



Multi-espace

Le tabouret est idéal pour les tables hautes dans les espaces projets ou restauration

Indoor et outdoor

Traitement anti-UV et anti-corrosion (piètement blanc et noir uniquement)

Personnalisable

3 couleurs de pieds au choix : chromé, noir ou blanc

Lavable

(coque polypropylène)



Empilables

Pour un rangement et un transport facilité

Nuancier

Polypropylène

Assise

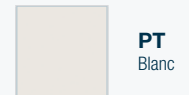

PT
Blanc



QA
Gris



PU
Noir

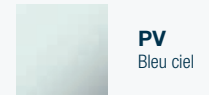

PV
Bleu ciel



QH
Vert forêt



XK
Rouge

Métal

Piètements



SQ
Chromé



SO
Blanc



SG
Noir

TARIF P. 133

Détails et disponibilités

**TOUTES LES RESSOURCES
EN LIGNE**





Line

Tables LUCIE, p.218

LA CHAISE BISTROT REVISITÉE

Inspirée des chaises de café des années 20, LINE surpasse ses ancêtres en bois par sa technicité. Fabriquée en une pièce de polypropylène, LINE résiste aux intempéries. Indoor ou outdoor, pratique et confortable, elle signe les espaces restauration d'un style vintage revisité.



Chaises

...



Points forts



Color block

Couleur des pieds assortie à la couleur de la coque



Lavable et pratique

La version avec accoudoirs permet un appui sur table pour faciliter le nettoyage des sols



Indoor et outdoor

Traitement anti-UV



Légères

Elles se transportent et s'empilent facilement (jusqu'à 10 pièces)

Nuancier

Polypropylène

Assise, dossier et piétement



PT
Blanc



PO
Rouge grenat



PP
Vert foncé



PU
Noir



PI
Gris chaud

TARIF P. 133

Détails et disponibilités

**TOUTES LES RESSOURCES
EN LIGNE**





Gaby

NOUVEAU

DESIGN & RETRO

Imaginée par notre Studio Design, GABY est idéale pour aménager vos espaces de restauration. Avec son look bistrot, elle se distingue par son style unique et chaleureux. Composée de tables, chaises et tabourets déclinés en plusieurs finitions, GABY crée une ambiance conviviale et authentique.

Fabriqué
en France





Points forts



Look bistrot

Parfait pour aménager vos espaces de restauration



Gamme complète

Chaises et tabourets assortis aux tables



Choix personnalisé

Hêtre teinté noir ou chêne multiplis



Zooms



Design unique et arrondi

Des lignes courbes alliant confort et style



Généreuse et confortable

Largeur d'assise L. 44 cm



Dossier design

Élégant et offrant un soutien optimal

Nuancier

Bois multiplis

Assise et dossier

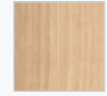

VA
Chêne



VO
Hêtre teinté
noir

Métal

4 pieds



ZP
Noir

TARIF P. 134

Détails et disponibilités

**TOUTES LES RESSOURCES
EN LIGNE**



GABY existe aussi en tables
p. 220



Sofia

NOUVEAU

Table haute ELISA, p. 214

LA CHAISE À L'ESPRIT 50'S

SOFIA allie subtilement le charme rétro des années cinquante et la rigueur du style nordique. Cette double alliance lui donne une grande polyvalence de style. Disponible en version polypropylène ou tapissée, elle s'adapte à tous les espaces. Le tabouret pour les tables hauteur 90 cm complète la gamme, alliant style et fonctionnalité.





Points forts



Une gamme complète

Chaise et tabouret en version polypropylène ou tapissée
Tabouret H. 67.3 cm :
adapté pour les tables H. 90 cm
(ARIAL)

Multi-espace

Une gamme polyvalente
qui s'adapte à tous les espaces

Détail des finitions

Une assise et un dossier avec
des lignes douces et arrondies
pour un usage prolongé



Zooms



Douceur des lignes

Tubes fins pour un design épuré



Confort

Version entièrement tapissée

Nuancier

Tissu Cat. B

Assise et dossier

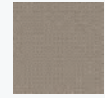

A2
Beige



A5
Jaune
moutarde

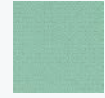

E4
Vert
d'eau



B5
Gris clair
chiné



A6
Noir



A9
Vert
anglais

Polypropylène

Assise



QN
Jaune
ocre



PU
Noir

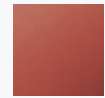

QO
Rouge
Marsala



QW
Taupe



QS
Vert
Saugé

Métal

4 pieds

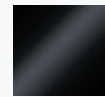

SG
Noir

TARIF P. 135

Détails et disponibilités

**TOUTES LES RESSOURCES
EN LIGNE**





Évasion

POUR UN ESPACE NATUREL

Alliance subtile du métal et du hêtre naturel, la gamme ÉVASION séduit grâce à ses lignes graphiques et élancées. Complète, elle propose autant des tables que des assises coordonnées. Disponible en plusieurs formes et dimensions, ÉVASION s'adapte aussi bien aux espaces de restauration qu'aux espaces de réunion.

Fabriqué
en France





Points forts



Lavable et résistante

(assise en hêtre multipli stratifié, chant huilé)



Multi-espace

Une gamme polyvalente qui s'adapte aux espaces de réunion ou restauration



Confortable

Repose-pieds zingué anti-traces



Zooms



Ergonomique

Prise de main intégrée au dossier



Insert métal associé au bois massif

Blanc ou noir, il apporte un style moderne



Style naturel

Pieds en hêtre massif

Nuancier

Hêtre

Assise et décor
Finition structurée



VKZOMS
Blanc
Hêtre massif



VMZPMS
Noir
Hêtre massif

Hêtre

Assise et décor
Finition lisse



VKSOMS
Blanc
Hêtre massif



VMSGMS
Noir
Hêtre massif

TARIF P. 134

Détails et disponibilités

TOUTES LES RESSOURCES
EN LIGNE



ÉVASION existe aussi en tables p. 216
et table basse p. 47



Accessoires & Connectique



Accessoires & Connectique



Luminaire NOUVEAU

Page 272 ›

.....



Végétaux décoratifs NOUVEAU

Page 274 ›

.....



Tri sélectif

Page 278 ›

.....



Porte-manteaux NOUVEAU

Page 280 ›

.....



Vestiaire mobile NOUVEAU

Page 281 ›

.....

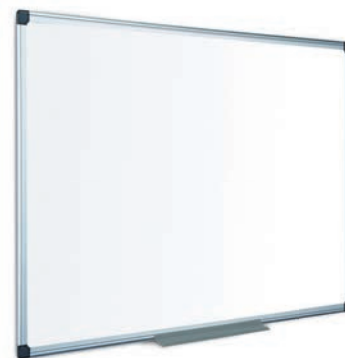

Tableaux écritoires & affichage

Page 281 ›

.....



Accessoires de bureau

Page 282 ›

.....



Supports multimédia

Page 283 ›

.....



Bras support écran

Page 284 ›

.....



Connectique

Page 286 ›

.....

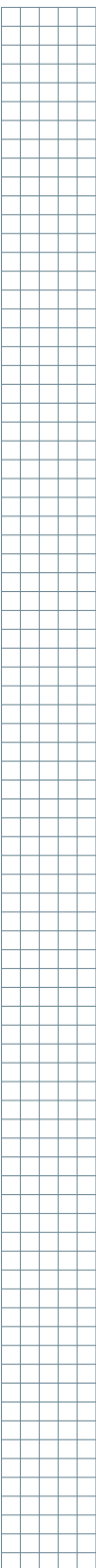

Lampes



AVA - 150 lumen

Utilisation intérieure / extérieure
(certifiée IP44)
Sans-fil rechargeable
(câble USB fourni)
Hauteur 31 cm



CHAMPI - 459 lumen

Variateur d'intensité
Interrupteur sensible
Hauteur 26 cm



AURA - 997 lumen

3 intensités d'éclairage
1 articulation
Port USB A 5V intégré
Hauteur 18-53 cm



OL07 - 510 lumen

3 intensités d'éclairage
3 températures de couleur
Bras flexible
Hauteur 48 cm



OL02 - 650 lumen

5 intensités d'éclairage
3 températures de couleur
Port USB + chargeur induction
Hauteur 38 cm



Nuancier

Ava



Noir Vert tilleul Beigerot Orange pastel

Champi



Blanc Gris Noir Rose

OL07

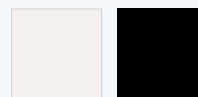

Blanc Noir

OL02



Blanc/Argent

Lampadaires

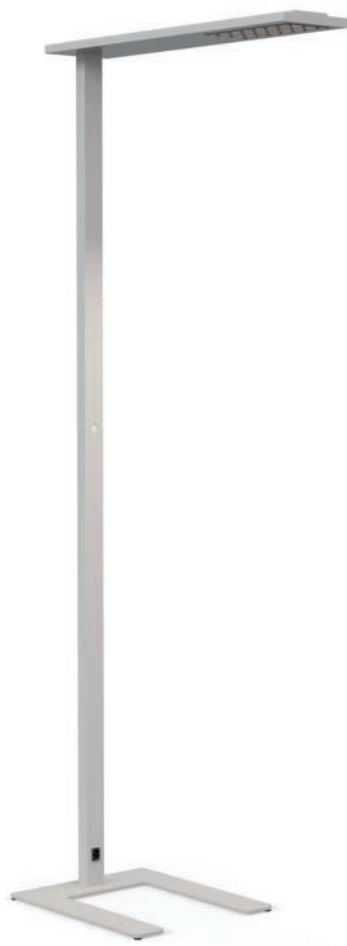

^ **NEO - 11900/12421 lumen**
 En version 3000K ou 4000K
 Eclairage direct / indirect
 Détecteur de présence et capteur de luminosité intégrés
 Hauteur 198 cm



^ **CL05 - 1150 lumen**
 Abat jour façon bois ou lin
 Pied bois teinté
 Hauteur 155 cm



^ **AURA - 5539 lumen**
 Variateur d'intensité
 Finition acier et bois
 Hauteur 180 cm



^ **CL09 - 1100 lumen**
 Abat jour en chinz
 Pied avec tablette intégrée en métal peint
 Hauteur 147 cm



Neo

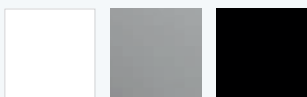

Blanc

Aluminium

Noir

CL05

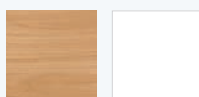

Bois

Blanc

Aura



Blanc/Hêtre

Noir/Hêtre

CL09



Noir

TARIF P. 138-139

Détails et disponibilités

**TOUTES LES RESSOURCES
 EN LIGNE**



Végétaux

NOUVEAU



Tables ROBIN, p. 170 - Tabourets SOFIA, p. 264

DÉCORATIFS ET DE SÉPARATION

Notre gamme de végétaux décoratifs a été pensée pour favoriser un environnement de travail apaisant et stimulant. De toutes tailles, les végétaux décoratifs peuvent aussi bien être posés sur les bureaux ou tables de réunion qu'être utilisés pour délimiter les espaces de travail transformant ainsi votre bureau en un lieu inspirant et accueillant.

Végétaux décoratifs en pot



Hosta

H. 22 cm ø 13 cm

Pot noir en céramique



Agave

H. 22 cm ø 13 cm

Pot blanc en céramique



Succulente

H. 30 cm .ø 15 cm

Pot strié en céramique

Fabriqué
en France



Végétaux décoratifs en bac



Points forts

Sépare les espaces

Différentes hauteurs au choix



Habillage de finition

Gravillons décoratifs en quartz ou calcaire



Léger & qualitatif

Bac en fiberstone, ou plastique, matériaux légers



Graminées

H. 180 / L. 90 cm

Bac H. 77 cm en plastique anthracite

A poser au sol



Fougères / Alocasias

H. 135 / L. 90 cm

Bac H. 77 cm en plastique anthracite

A poser au sol



Graminées

H.70 / L.80 cm

Jardinière H. 20 cm en fiberstone blanc

A poser sur un dessus de meuble



Composition mélangée

H.70 / L.80 cm

Jardinière H. 20 cm en melamine blanc

A poser sur un dessus de meuble

TARIF P. 140

Détails et disponibilités

TOUTES LES RESSOURCES
EN LIGNE



Fabriqué
en France



Végétaux décoratifs en pot

Points forts

Des ensembles complets

Pot, plante et habillage inclus



Bois naturel

Feuillage artificiel



Associations uniques

Pots et plantes



Graminée

H. 160 cm

Pot rond ø 35 cm en polyéthylène laqué noir



Bambou

H. 175 cm

Pot carré 40x40 cm en polyéthylène mat noir

Fabriqué
en France





Alocasia

H. 95 cm

Pot en corde tressée



Dracaena Fragrans

H. 130 cm

Pot en bambou tressé



Lyrata royal

H. 120 cm

Pot en corde tressée



Eucalyptus

H. 150 cm

Pot en plastique recyclé noir

TARIF P. 140

Détails et disponibilités

**TOUTES LES RESSOURCES
EN LIGNE**





Tri sélectif

Fabriqué
en France





Points forts



Capacité 60 L

Avec bac plastique extractible (inclus)



Pictogrammes colorés

Pour identifier la destination des déchets



Mobile

Elle se déplace facilement



Robuste

Tôle d'acier ép. 10 mm



Options



Pièces de liaison



Couvercle

Recommandé pour la poubelle organique



Porte arrière

TARIF P. 142

Détails et disponibilités

**TOUTES LES RESSOURCES
EN LIGNE**



Porte-manteaux



^ **Saphir** 
8 patères
Porte-parapluies réglable
en hauteur
Egouttoir intégré
H.171 cm - Base ø 36,5 cm

^ **Noa** 
4 patères
Embouts en bois
H. 179,5 cm - Base ø 36,5 cm

^ **Aura** 
6 patères
6 emplacements parapluies
Egouttoir intégré
H. 178 cm - Base ø 34 cm

^ **Bora** 
6 patères
6 emplacements parapluies
Egouttoir intégré
H. 178 cm - Base ø 34 cm

Nuancier

Saphir



Noir

Noa



Noir

Aura



Blanc/Hêtre



Noir

Bora



Blanc/Bambou



Noir/Bambou

TARIF P. 143

Détails et disponibilités

TOUTES LES RESSOURCES
EN LIGNE



Vestiaire mobile



Etagère inférieure pour accessoires,
Capacité : 40 cintres



Nuancier

Vestiaire mobile



Chromé

TARIF P. 143

Détails et disponibilités

TOUTES LES RESSOURCES
EN LIGNE



Tableaux écritoire



Fixation verticale ou horizontale (visserie fournie)

Kit accessoires : Marqueurs + aimants + brosse magnétique + produit nettoyant (en option)



Cadre aluminium

Laqué 90 x 120 cm

Émaillée 60 x 90 cm, 90 x 120 cm,
120 x 180 cm

Surface magnétique et effaçable à sec



Sans Cadre

Laqué 75 x 115 cm

Surface magnétique et effaçable à sec



Chevalet mobile

H. 186 cm

Fond magnétique en tôle laquée

TARIF P. 144

Détails et disponibilités

TOUTES LES RESSOURCES
EN LIGNE



Tableau affichage



Fixation verticale ou horizontale (visserie fournie)



Cadre aluminium

Liège naturel ép. 12 mm
60 x 90 cm – 90 x 120 cm

TARIF P. 144

Détails et disponibilités

**TOUTES LES RESSOURCES
EN LIGNE**



Accessoires de bureau



Tiroir vide poches

En métal
Fixation sous plateau



Repose pieds

Hauteur réglable sur :
4 positions et 4 angulations



Corbeille métallique

Capacité 19L

TARIF P. 145

Détails et disponibilités

**TOUTES LES RESSOURCES
EN LIGNE**



Support clavier

Supports UC



Finition ABS

Fixation sous plateau
Porte crayons intégré
Réglage en hauteur de 2 à 5 cm



Support par bras métal

Finition gris aluminium, blanc ou noir
Conseillé pour bureaux AXEL 2
& LUTZ 2



Support par bras métal

Finition gris aluminium

Tables informatiques



Table multiusage mobile

Plateau mélamine blanc ép. 25 mm
Structure métallique gris aluminium



Poste informatique

Plateau mélamine hêtre ép. 19 mm
Structure métallique gris clair
Équipée de 4 roulettes dont 2 avec freins

TARIF P. 146

Détails et disponibilités

TOUTES LES RESSOURCES
EN LIGNE





Bras supports écrans



Économique

4 articulations sur mat

Pour 1 ou 2 écrans

Taille d'écran : de 10 à 32 pouces

Charge maxi : 8 kg

Fixation au plateau : sur pince ou tige (par percement plateau)



Standard

4 articulations avec ressort à gaz

Pour 1 ou 2 écrans

Taille d'écran : de 17 à 32 pouces

Charge maxi : 9 kg

Fixation au plateau : sur pince ou tige (par percement plateau)

TARIF P. 147

Détails et disponibilités

**TOUTES LES RESSOURCES
EN LIGNE**





Technique

Bras articulé en aluminium à vérin pneumatique simple ou double extension (portée 28,3 cm ou 43,3 cm).

Guide câbles intégré

Pivote à 360°

Taille d'écran : jusqu'à 27 pouces.

Charge maxi : 7 kg

Un système évolutif, pour 1 ou 2 écrans !

1 Choisir sa longueur de bras



Portée 28 cm - Simple extension

Bras simple ou double



Portée 43 cm - Double extension

Bras simple ou double

2 Choisir sa fixation



Fixation 3 en 1

Pour plateaux ép. 10 à 50 mm

Sur pince P. 25 mm



Sur pince P. 65 mm

Pour plateaux ép. 13 à 25 mm

Compatibles avec panneaux écrans SOLANGE (p. 122)



Pinces disponibles pour 1 ou 2 écrans

Tous nos bras supports écrans sont compatibles avec la norme VESA 75 ou 100 mm



Connectique

Tables ROBIN, p. 170 - Tabourets SOFIA, p. 264

QUELLE CONNECTIQUE POUR MON BUREAU ?

La connectique est un élément important du bien-être des collaborateurs ! Elle doit être facilement accessible et discrète pour ne pas prendre trop de surface de travail. Pour connecter son smartphone, sa tablette, son PC, les solutions sont nombreuses et s'adaptent à votre usage.

Pour une solution économique

Optez pour un obturateur simple pour le passage des câbles, ou un bloc prise posé directement dans la goulotte. Il sera accessible à travers un plateau coulissant, avec échancrure ou via une trappe sans nourrice



^
Obturbateurs simples



^
Bloc prises avec courant fort
Connectique au choix avec port USB A ou C, RJ45 ou HDMI



^
Câbles d'alimentation
2 ou 3 mètres

Pour les populations nomades ou les espaces flexibles

Le choix d'une connexion directe : un mode de connexion rapide et pratique



Obturbateurs électrifiés

Avec ou sans capot coulissant

Selon modèle avec courant fort, port USB A ou C, RJ45 ou HDMI



Boîtiers nomades

Selon modèle en format bloc prises

Pour les populations sédentaires ou les espaces premium

Le choix du confort et de l'esthétique avec une trappe d'accès : elle masque le bloc prises, tout en permettant un accès direct à la connectique

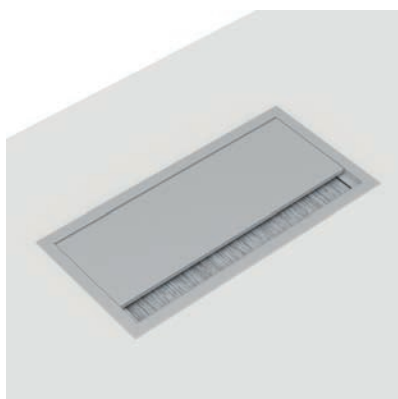

Trappes soft-closing

Trappe simple accès ou double accès



Avec ou sans bloc prises

Connectique au choix : avec ports USB A ou C, RJ45 ou HDMI



TARIF P. 148

Détails et disponibilités

TOUTES LES RESSOURCES
EN LIGNE





Bureaux AXEL 2, p. 114 -
Sièges OPUS, p. 233 -
Armoires ARMAND, p.142 -
Ecrans SOLANGE, p. 232 -
Assises MARGOT, p. 34

Gestion des fluides

COMMENT BIEN ORGANISER LES CÂBLES ?

Pour un espace ordonné propice à la concentration et au bien-être des collaborateurs, mieux vaut organiser la gestion des câbles. Goulotte simple ou double, carter ou vertèbre, nous avons la solution à votre usage !

Organisez les câbles sous le plateau

Grâce à une goulotte ou un organisateur de câbles pour bureau individuel ou partagé.



^
Goulottes métalliques
Simple ou double



^
Goulotte filaire



^
Organisateur de câbles
(Lot de 2)

Masquez les câbles qui descendent vers le sol

Au choix : un carter aimanté sur le pied
ou des solutions plus souples comme la vertèbre extensible ou la gaine zippée



^
Carters métalliques

Aimanté sur un pied de bureau



^
Vertèbres extensibles
Pour bureaux fixes ou réglables
en hauteur

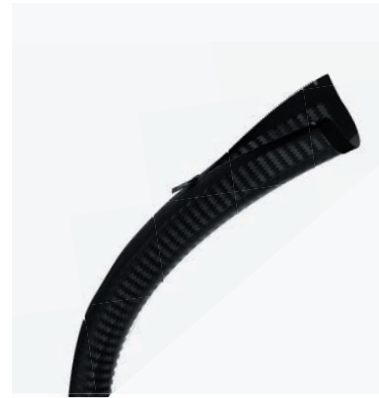

^
Gaine zippée
2 longueurs au choix : 75 et 150 cm

Choisissez un voile de fond

Les voiles de fond sont des compléments optionnels apportant un meilleur confort personnel et permettant de préserver l'intimité des collaborateurs.

Fixation par inserts ou vis à bois sous le plateau

Disponibles en métal, mélamine ou tissu



^
Voiles de fond métalliques



^
Voiles de fond tissu
Plaque métallique de rigidification



^
Voiles de fond mélamine
Ép. 19 mm

TARIF P. 150
↓
Détails et disponibilités

**TOUTES LES RESSOURCES
EN LIGNE**
↓



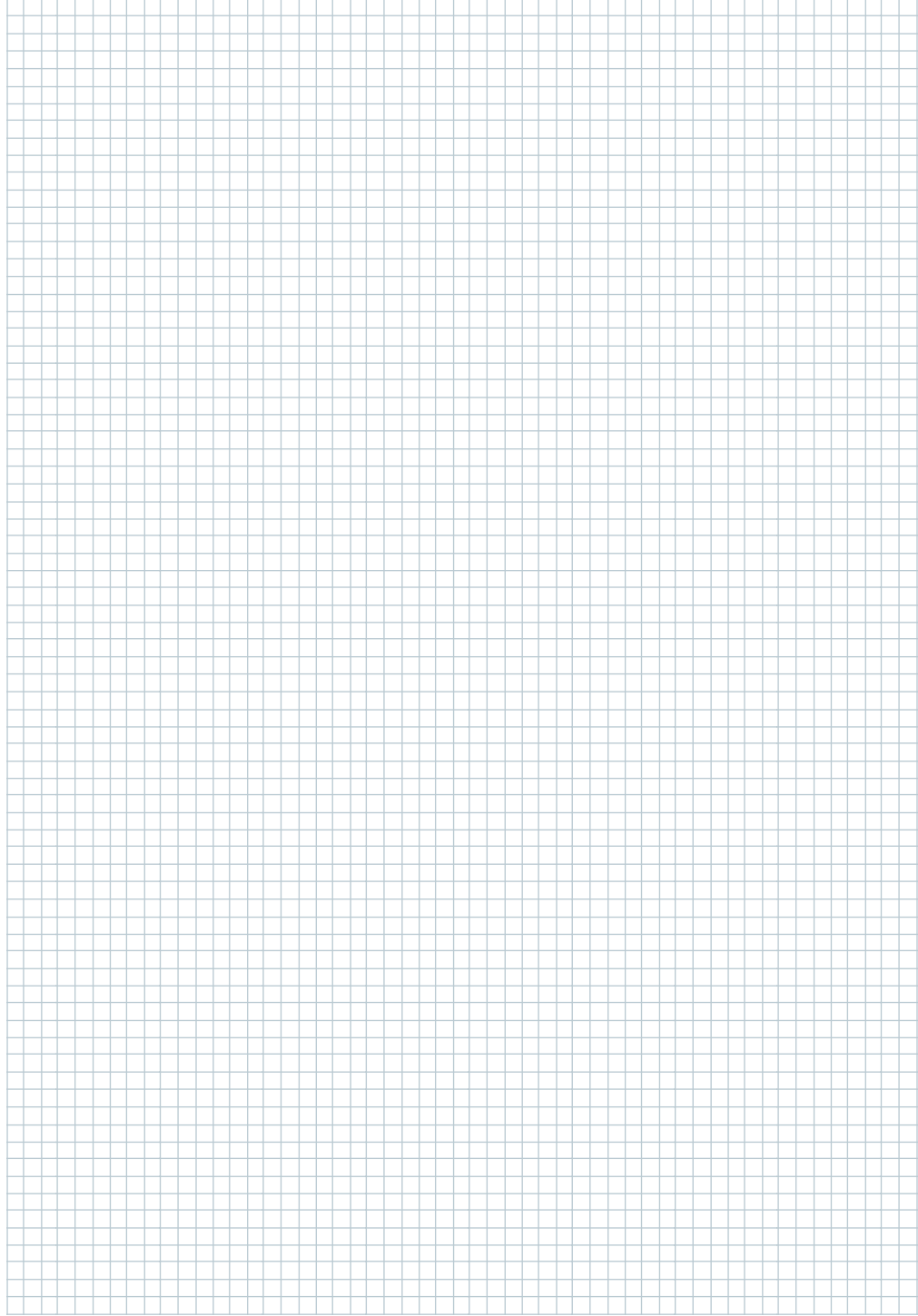

Nuancier



Mélamine bois

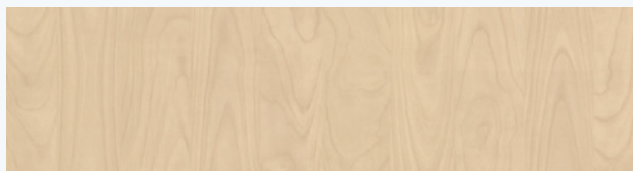

N8*
Pin maritime



RZ
Acacia de Lakeland

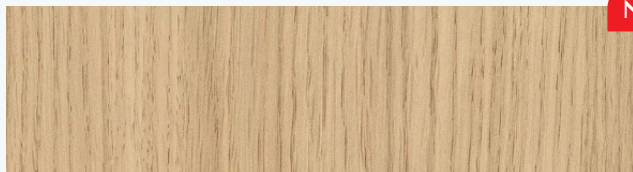

R1
Chêne naturel



R5
Hêtre clair

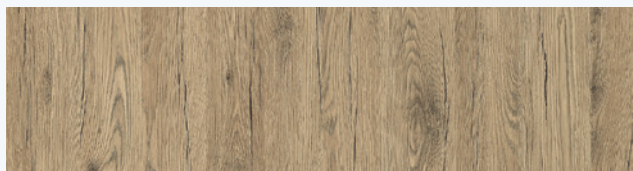

R3
Chêne Brunswick

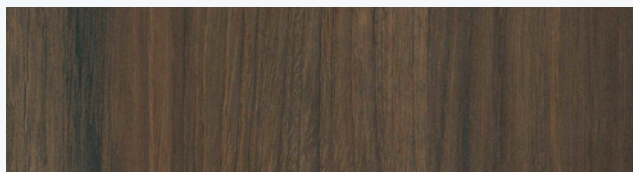

N6
Noyer brun



RK
Bois noir

*N8 Pin maritime : chants spécifiques multiplis

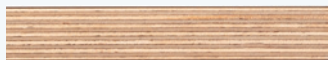

Mélamine unis

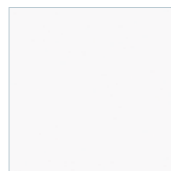

MG
Blanc neige



N5
Lin



R7
Vert avocat



R8
Rose blush



R6
Bleu Poséidon

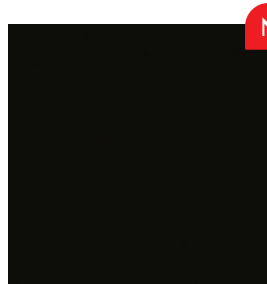

R9
Noir



Toucher velours



Anti-traces de doigts

Stratifié

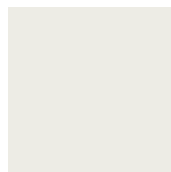

HZ
Blanc



VW
Noir

Altuglas®



OA
Blanc satin

Métal lisse



SO
Blanc

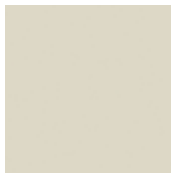

ZC
Blanc nacré

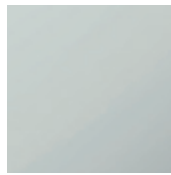

SD
Gris clair

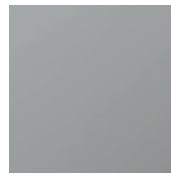

SA/SB*/Z4**
Gris aluminium



SG
Noir



ZG
Vert réséda



ST
Vert anglais



X4
Bleu cobalt



Z9
Jaune signal



Z8
Nude



Z3
Laiton

Métal structuré



ZO
Blanc

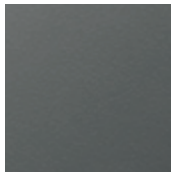

SU
Gris souris



SC
Anthracite



ZP
Noir

*SB : spécifique Rangements

**Z4 : spécifique Bureaux AXEL 2 et LUTZ 2

Bondai (Cat. A)

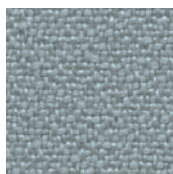

KD
Gris nuage

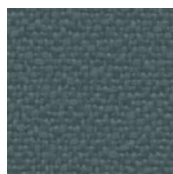

KA
Gris orange



KE
Noir

Chili (Cat. B)



BC
Gris clair chiné

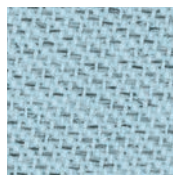

BF
Bleu givré chiné

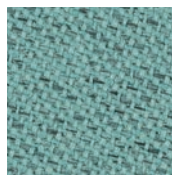

BG
Céladon chiné

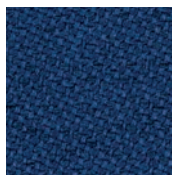

BH
Bleu minuit chiné

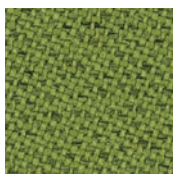

BK
Vert olive chiné



BL
Saumon chiné



BM
Beige chiné



BO
Curcuma chiné

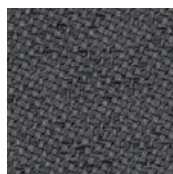

BN
Chocolat chiné

Step/Step Mélange (Cat. B)

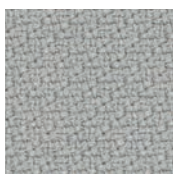

E5
Gris clair



A6
Noir



E4
Vert d'eau

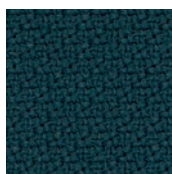

A4
Bleu pétrole

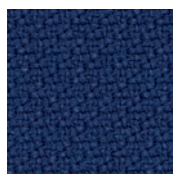

A3
Bleu marine

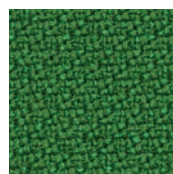

A1
Bambou

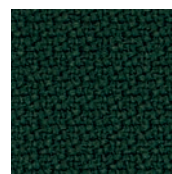

A9
Vert anglais



A2
Beige

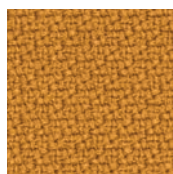

A5
Jaune moutarde



E6
Tomette

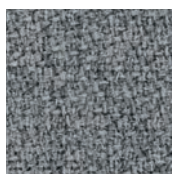

B5
Gris clair chiné



B1
Anthracite chiné



E7
Vert d'eau chiné



B4
Bleu denim chiné



B6
Marine chiné

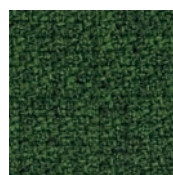

B2
Bambou chiné



E9
Jaune moutarde
chiné

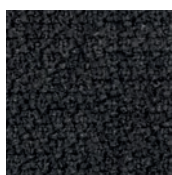

B7
Marron foncé chiné

Secret (Cat. C)

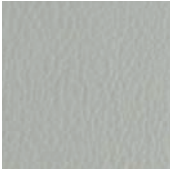

CA
Gris perle

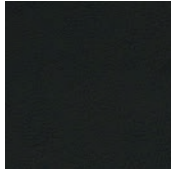

CB
Noir

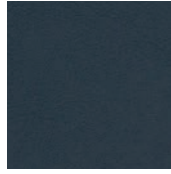

CC
Bleu minéral

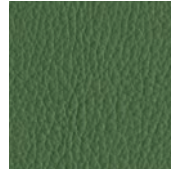

CE
Vert olive

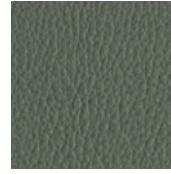

CF
Vert de gris foncé



CG
Argile



CH
Taupe

Fenice (Cat. D)

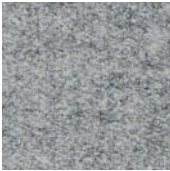

DA
Gris clair chiné

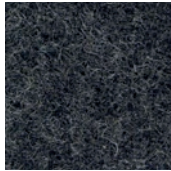

DB
Antracite chiné

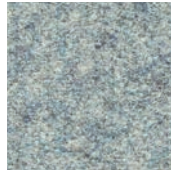

CJ
Bleu clair chiné

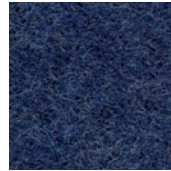

DC
Bleu foncé chiné



DF
Céladon chiné

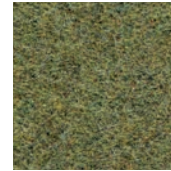

DE
Vert olive chiné



DG
Vert foncé chiné

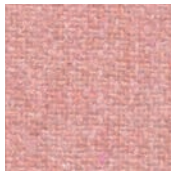

DH
Rose poudré

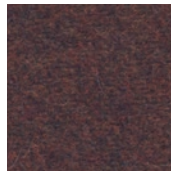

DZ
Terre de Sienne

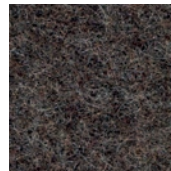

DD
Chocolat chiné



DI
Curcuma chiné



DJ
Rouille chiné

Cyber (Cat. D)

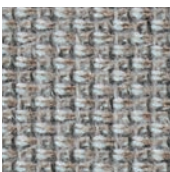

T8
Gris clair

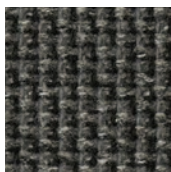

T9
Gris foncé

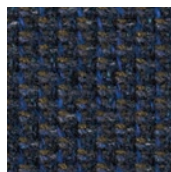

T5
Gris bleu

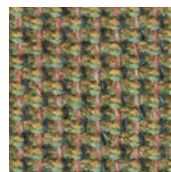

TZ
Vert amande

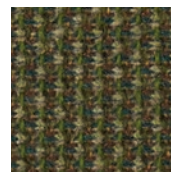

TU
Vert fougère

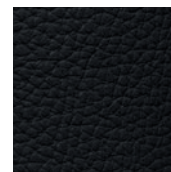

YB
Noir



TL
Beige doré

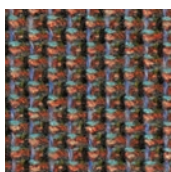

T6
Saumon chiné

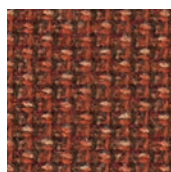

T7
Rouille

Cuir (Cat. E)

TABLEAU DES FINITIONS



CONSULTER LE DÉTAIL
DES FINITIONS PAR GAMME
P. 152 DU TARIF

Caractéristiques techniques

Mélamine Stratifié	Mélamine				Stratifié
	Epaisseur 19 mm		Epaisseur 25 mm	Epaisseur 30 mm	Epaisseur 25 mm
	Plateaux	Portes / Corps / Habillages	Plateaux	Plateaux	Plateaux
Revêtement double face, traité anti-reflets	✓	✓	✓	✓	✓
Finitions*	MG - R1	Toutes	Toutes	MG - R1 - N6 - R3 - RK	HZ - VW
Chants plats ABS anti-chocs et rayonnés ⁽¹⁾	✓	✓	✓	✓	✓
Anti-bactérien	✓	✓	✓	✓	✓
Densité ⁽²⁾	620 > 690 kg/m ³		600 > 670 kg/m ³	640 kg/m ³	620 > 640 kg/m ³
PEFC (issus de forêts gérées durablement)	✓	✓	✓	✓	✓
Certifiés E05 (conforme à la norme NF EN 717-2)	✓	✓	✓	✓	✓
Classement au feu (conforme à la norme NF EN 13501-1)	Classement M3 (D-S2,d0 EUROCLASS) pour tous les décors.				
% moyen issu de matière recyclées (pré- et post-consommation)	68 % en moyenne. 90% pour les coloris R3, R6, R7, R8 et N8 certifiés CRADLE to CRADLE.				85%
% recyclabilité	100%				100%
Entretien	Passer un chiffon humide avec une eau savonneuse. A éviter : produits abrasifs et détergeants.				

(1) Chants assortis au coloris du plateau excepté pour le coloris N8 (chants multiplis) et les plateaux stratifiés de la gamme Evasion
Chants ABS 2 mm (majoritairement) et 1 mm non rayonnés

(2) Densité : Tolérance +/- 10%

* Finition R9 – voir Fiche technique du produit

Caractéristiques techniques

Tissu	Composition	Poids du tissu	Nombre de tours d'abrasion	Tenue à la lumière	Résistance au frottement	Normes anti feu	Environnement
Bondaï Cat. A	100% polyester	350 g/ml (lm) 250 g/m ² ±5%	150 000 EN ISO 12947-2	6 EN ISO 105-B02	4-5 EN ISO 105 x 12 Mouillé-Sec	EN 1021 - 1&2 BS 7176 BS 5852 Crib5	STANDARD 100 by OEKO-TEX®
Chili Cat. B	100% polyester recyclé post-consommation fr (fr à l'intérieur de la fibre)	470 g/ml (lm) (15.16 oz / lin yd)	60 000 EN ISO 12947-2	5-8 EN ISO 105-B02	4-5 EN ISO 105 x 12 Mouillé -Sec	EN 1021 - 1&2 NFP 92-503/504/505 M1 NF D 60-013 AM18 BS 7176 BS 5852 Crib 5 DIN 4102 B1 EN 13501	STANDARD 100 by OEKO-TEX® Fibre 100% recyclée Basse émission de COV
Step Step Mélange Cat. B	100% trevira® CS	470 g/m ² (15.16 oz / lin yd)	100 000 EN ISO 12947-2	5-7 EN ISO 105-B02	4-5 EN ISO 105 x 12 Mouillé-Sec	EN 1021 - 1&2 NFP 92-503/504/505 M1 NF D 60-013 AM18 BS 7176 BS 5852 Crib 5 DIN 4102 B1 EN 13501	STANDARD 100 by OEKO-TEX® EU Ecolabel Teintures non métalliques Basse émission de COV
Secret Cat. C	76% PVC - 22% PES - 2% PU Protection antibactérienne	540 g/ml (lm) ±10 g/m ²	60 000 EN ISO 5470-2	6-7 EN ISO 105-B02	5-5 EN ISO 105 x 12 Mouillé-Sec	EN 1021 - 1&2 BS 5852 1&2 UNI 9175 class 1IM TB 117:2013	Sans Phtalates
Fenice Cat. D	75% Laine 25% PA	335 g/m ² ±7% 500 g/ml (lm) ±7%	100 000 ±20% EN ISO 5470-2	6 ±1% EN ISO 105-B02	4-5 EN ISO 105 x 12 Mouillé-Sec	EN 1021 - 1&2 BS 5852 Crib 5 CLASS 1 IM CALIFORNIA TB 117	Tissu recyclable
Cyber Cat. D	100% polyester recyclé post-consommation	570 g/ml (lm) (18.39 oz / lin yd)	120 000 EN ISO 12947-2	7-8 EN ISO 105-B02	4-5 EN ISO 105 x 12 Mouillé-Sec	EN 1021 - 1&2 BS 5852 Crib 5 CALIFORNIA TB 117	STANDARD 100 by OEKO-TEX® Fibre 100% recyclée Basse émission de COV

Index

4	4 LINE	96	L	Lampadaires	273
A	Accessoires de bureau	282		Lampes de bureau	272
	Accessoires de réunion	281		LÉO	136
	Accessoires pour rail	127 - 138		LÉON	230
	ALMA	182		LINE	260
	ALTER	227		LOUIS	244
	ANOUK	28		LUCIE	218
	ANTHRA+	247		LUTZ 2	110
	ARIAL bureaux mobile	86	M	MANHATTAN	236
	ARIAL réunion	164		MARGOT	34
	ARIV	152		MARTIN	192
	ARMAND	142		MEETING+	246
	Armoires démontables	154		MELINA	132
	Armoires à rideaux	150 - 152		MIA	226
	ATTITUD	237		MODULO	178
	AXEL 2	114	N	NAVERT	150
B	Banc	159 - 210		NOMAD	186
	Banques d'accueil	50 - 56	O	Obturbateurs	286
	BIP	42		OPUS	233
	Boîtiers prises	286		OSCAR 2	228
	Bras supports écrans	284	P	Panneaux écrans	120 - 122
	Bureaux assis-debout	110 - 114		PING	196
C	Câbles d'alimentation	286		Portemanteaux	280
	Caissons mélamine	130 - 133		Poutres	62 - 63
	Caissons mélamine éco	133	R	Rayonnages	156
	Caissons métal	130		Rehausse	135
	CAMILLE casiers	146		Repose-pieds	282
	Canapés	22 - 28 - 34 - 40 - 41		RIO	68
	CHATBOX	198		ROBIN bureaux	100
	Chevalet	281		ROBIN direction	76
	Classeurs	155		ROBIN réunion	170
	Cloisons	120 - 122		ROMY	256
	CÔME	40		ROSALIE chaises	248
	CONNECT	90		ROSALIE poutres	63
	Corbeilles de bureau	282	S	SCOTT	250
	Corbeilles de tri sélectif	278		SEVEN	238
E	ELIOTT	234		Siège 24H Pro	239
	ELOISE	210		Sièges dessinateurs	228 - 234 - 239
	ELISA	214		Siège polyuréthane	239
	EMI table	202		SOFIA	264
	EMI chaises	254		SOLANGE	122
	EVASION chaises	266		SOSI poutres	63
	EVASION poutres	62		Support clavier	283
	EVASION tables	216		Support UC	283
F	FORSTYL	104		SUZY	48
G	GABIN	232	T	Tableaux	281
	GABY chaises	262		Tables abattantes	206
	GABY tables	220		Tables basses	46
	Gaine zipée	289		Tables informatiques	283
	GALWAY	41		Tables outdoor	218
	GELATI	258		Tables pliantes	203
	GEO	247		Tables polyvalentes	204
	Gestion des fluides	288		Tabourets	248 - 258 - 262 - 264 - 266
	GRETA	50		Towers	136 - 138
	Goulottes	288		Trappes	287
	GUEST	56		TWINS	120
	GUSTAVE	138	V	Végétaux décoratifs	274
I	IDOL	106		Vestiaires	158
	INVENTIV	242		Voiles de fond	289
	ISABEL	243	Z	ZÉLIE	22
J	JAMES	140			
K	KARA	70			
	KARL bureaux	80			
	KARL réunion	172			